

## Original Study

## Open Access

Krzysztof Skrzypkowski\*, Waldemar Korzeniowski, Krzysztof Zagórski, Ireneusz Dominik, Krzysztof Lalik

# Fast, non-destructive measurement of roof-bolt loads

<https://doi.org/10.2478/sgem-2019-0013>

received February 22, 2019; accepted May 10, 2019.

**Abstract:** This paper discusses the pull-out laboratory tests and the monitoring of expansion-shell bolts with a length of 1.82 m. The bolts comprised the KE-3W expansion shell, a rod with a diameter of 0.0183 m and a profiled, circular plate with a diameter of 0.14 m, and a gauge of 0.006 m. The bolts were installed in a concrete block with a compressive strength of 75 MPa. The tests were conducted on a state-of-the-art test stand owned by the Department of Underground Mining of the AGH University of Science and Technology. The test stand can be used to test roof bolts on a geometric scale of 1:1 under static and rapidly varying loads. Also, the stand is suitable for testing rods measuring 5.5 m in length. The stand has a special feature of providing the ongoing monitoring of bolt load, displacement and deformation. The primary aim of the study was to compare the results recorded by two different measurement systems with the innovative Self-Excited Acoustic System (SAS) for measuring stress variations in roof bolts. In order to use the SAS, a special handle equipped with an accelerometer and exciter mounted to the nut or the upset end of the rod was designed at the Faculties of Mining and Geoengineering and Mechanical Engineering and Robotics of the AGH University of Science and Technology. The SAS can be used for non-destructive evaluation of performance of bolts around mining workings and in tunnels. Through laboratory calibration tests, roof bolt loads can be assessed using the in-situ non-destructive method.

\*Corresponding author: Krzysztof Skrzypkowski, AGH University of Science and Technology, Faculty of Mining and Geoengineering, Al. Mickiewicza 30, 30-059 Krakow, Poland, E-mail: [skrzypko@agh.edu.pl](mailto:skrzypko@agh.edu.pl)

Waldemar Korzeniowski: AGH University of Science and Technology, Faculty of Mining and Geoengineering, Al. Mickiewicza 30, 30-059 Krakow, Poland

Krzysztof Zagórski, Ireneusz Dominik, Krzysztof Lalik: AGH University of Science and Technology, Faculty of Mechanical Engineering and Robotics, Al. Mickiewicza 30, 30-059 Krakow, Poland

**Keywords:** Expansion-shell bolt; monitoring; non-destructive method; laboratory tests.

## 1 Introduction

The determination of roof-bolt loads should consider how fast and simple the measurement will be, and also such factors as sensor access and readout and measurement accuracy. In addition, the testing should account for the risk that the sensor will be destroyed in the technological process, or that certain natural hazards will occur. The use of single roof-bolt load sensors for strength limit states makes it possible to take appropriate safety measures to protect mining crews against a sudden working collapse. Among the many factors affecting the stability of mine workings, the most notable include rock bursts,<sup>[4,19]</sup> faults,<sup>[2,14,25]</sup> potential rock bursts under abandoned workings<sup>[3]</sup> and the size of stoops.<sup>[1]</sup> State mining authorities also play a special role in improving the occupational health and safety conditions in mining.<sup>[7]</sup> When independent roof bolting is used in a rock that has the potential to generate seismic energy, the amount of energy absorbed by such bolting should be determined.<sup>[18,20,21]</sup> In order to ensure roof bolting effectiveness, measures must be undertaken to assess whether rock bolts have been installed properly. In the case of expansion-shell bolts, the tightening torque of the bolt nut tightened with a torque wrench is checked, and the load bearing capacity of the bolts is verified by pulling them out of the holes. Currently, Polish zinc, lead and copper mines commonly use roof-rock delamination detection systems.<sup>[5,22]</sup> For instance, the ‘Olkusz – Pomorzany’ mine has a detection system comprising five Bakelite plates or (like) Bakelite material and sleeves with two short rods pressed by the plates (Fig. 1a, 1b). Each plate has a diameter of 0.122 m and thickness of 0.0037 m. In the center of the plate, there is a hole with a diameter of 0.0297 m through which passes a sleeve with a diameter of 0.027 m and length of 0.103 m. Additionally, the plate has a hole with a diameter of 0.065 m through which passes a cord protecting the plate from falling on the working floor.

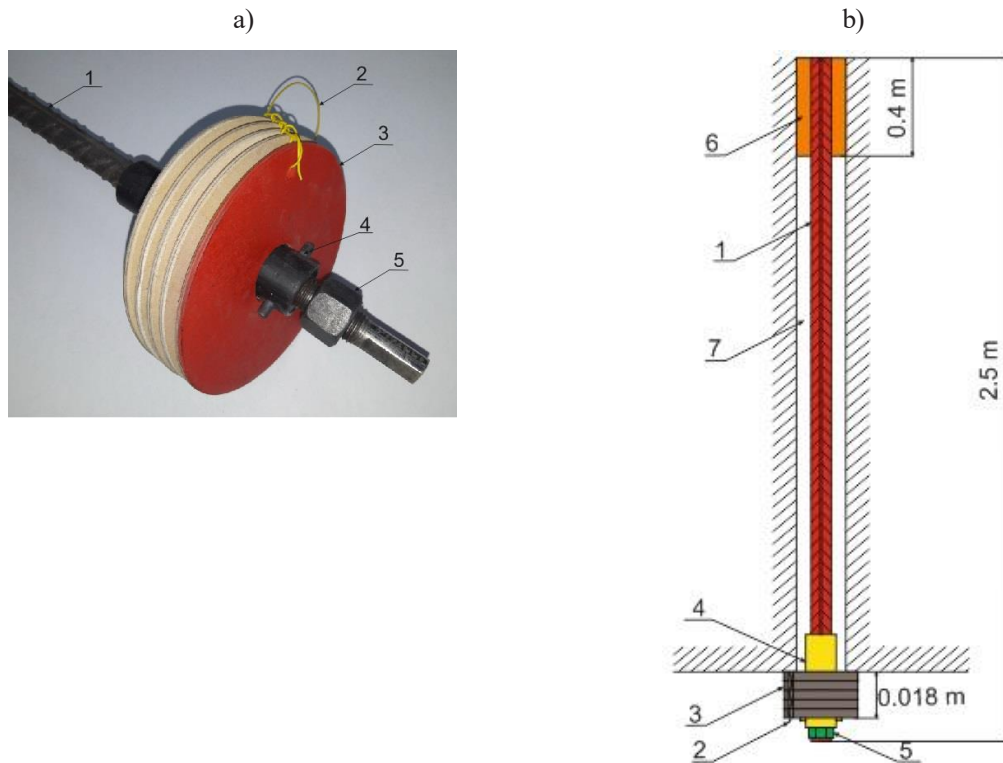

**Figure 1:** Roof-rock delamination detection system; a) Components; b) longitudinal cross-section; ribbed rod; 2 – cord; 3 – Bakelite plates or (like) Bakelite; 4 – sleeve with bars welded on it; 5 – nut; 6 – resin cartridge; 7 – bolt hole.

The roof-rock delamination detection system is installed on the roof bolting (a rod with a diameter of 0.016 m and length of 2.5 m) section-wise by resin anchoring (one resin cartridge with a diameter of 0.024 m and length of 0.4 m) at working intersections and on sites where fallen roof rocks have been found.

Roof bolts and rock behavior around workings can be monitored based on the measurements of: working roof loads (dynamometers: mechanical (Fig. 2a), electronic (Fig. 2b), instrumented bolts, pressure cushions, dynamometric rings); roof-rock delamination (low delamination, high delamination, extensometer probes); fracturing of roof layers (borehole endoscope, aerometric probe and radiometric probe); and convergence of mining excavations.<sup>[15]</sup>

An improved version of the delamination detection system is now available as the WK-2/8 remote-controlled mechanical gauge to measure the load exerted on bolts has been introduced. Essentially, the WK-2/8 prototype gauge (Fig. 2a, Fig. 2c) determines the load on bolts by measuring the relevant displacement resulting from an increase in the axial load on the rod. On the rod, between the neat lines (e.g., roof) and bolt nut or head, a device is installed that also works as a dynamometric

bolt plate. The device comprises two cylinders that are displaced against each other due to the compressive load on them, including the elastic components inside them, and the resulting increase in force. The pair of cylinders – the outer one with a larger diameter and the inner one with a smaller diameter – are facing each other with their concave sides and freely sliding onto each other, working against the resistance of accurately pre-calibrated elastic components. Measurement rings are placed on the inner cylinder and tight-fitted to prevent their spontaneous shifting due to the bolt load expressed as the axial force exerted along the bolt.<sup>[9,11]</sup> The thickness of each measurement ring is selected to match the load and deformation behavior of the elastic component. Once individual rings with known thicknesses have slid or dropped off, their number is determined visually, and in this indirect way, the value of the axial force exerted on the bolt is determined.

Roof-bolt loads can be measured using simple mechanical sensors with measurement springs, disks or cylinders between the roof or rib of the working and the bolt plate.<sup>[10,16]</sup> Measurement cylinders can be additionally equipped with strain gauges to accurately monitor the tension of rock bolts under static and dynamic loads.

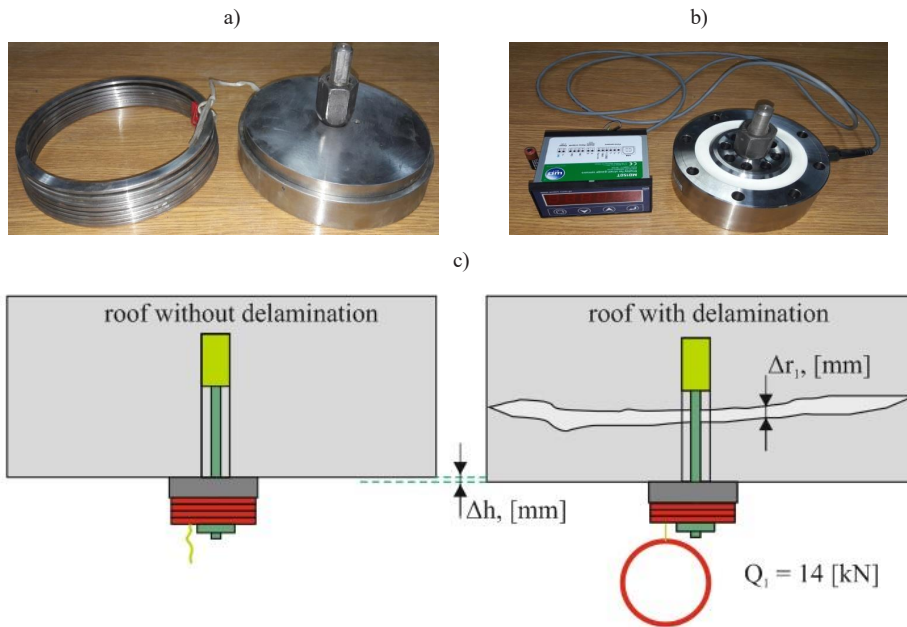

**Figure 2:** Roof-bolt load sensors; a) mechanical; b) electronic; c) operating principle of rock bolt loading indicator resulting from load increasing; r – delamination, h – subsidence, Q – load.

[17,23] One notable non-destructive method involves the experimental modal analysis by forcing vibrations of the test object using a hammer drill, with the receiving converter (accelerometer) placed on the portion of the rod protruding from the rock. This method is designed to identify whether the resin-anchoring of rods in the rock is continuous.<sup>[24]</sup> Another non-destructive method involves frequency measurement using the GRANIT system. In this method, a cylinder equipped with an accelerometer is screwed to the rod end protruding from the rock. Then, a load impulse with a low magnitude is triggered by a pneumatically driven piston. The transient response of the system is measured using the accelerometer, and subsequently, is converted into the frequency domain. The amplitude-frequency impulse spectrum was used to determine the length of the roof bolt. The GRANIT system was successfully applied in the roof bolt with a free length of more than 0.1 m.<sup>[6]</sup>

## 2 Description of the Self-Excited Acoustic System (SAS)

Elongation of structural members can be monitored using the Self-Excited Acoustic System (SAS). As an example, Figure 3a presents a diagram of the SAS for monitoring deformation of a straight beam. Elongation monitoring

device comprises an acoustic-vibration transmitter (1) connected via the amplifier (2) and conditioner (3) with an adjustable amplification factor and an acoustic-vibration receiver (4), forming an open circuit. The acoustic-vibration transmitter (1) is connectible with the monitored component (6), and the acoustic-vibration receiver (4) has a piezoelectric sensor connectible with the monitored component. Also, between the amplifier (2) and conditioner (3), a measurement and control block with a feedback connection to the conditioner (3) is tied in.<sup>[12]</sup> Data (frequencies) are recorded on an ongoing basis by a computer with LabVIEW software. As an example, Figure 3b illustrates the configuration of SAS sensors.

For the purposes of roof-bolt testing, mechanical vibrations are transmitted to the bolt by means of an electromechanical exciter, and subsequently, it is received by the accelerometer on the collar of the upset end of the rod. The signal is conditioned, amplified and then re-transmitted to the exciter. This configuration of the system made it possible to generate self-excited vibrations with a specific frequency. The frequency varies along with changes in the loading, in line with the electroacoustic effect.<sup>[13]</sup> Thus, the measurement of self-excited frequency facilitates the indirect assessment of the factor of safety of the tested bolt. The following equation is used to determine the relationship between the self-excited frequency and the load on the component:

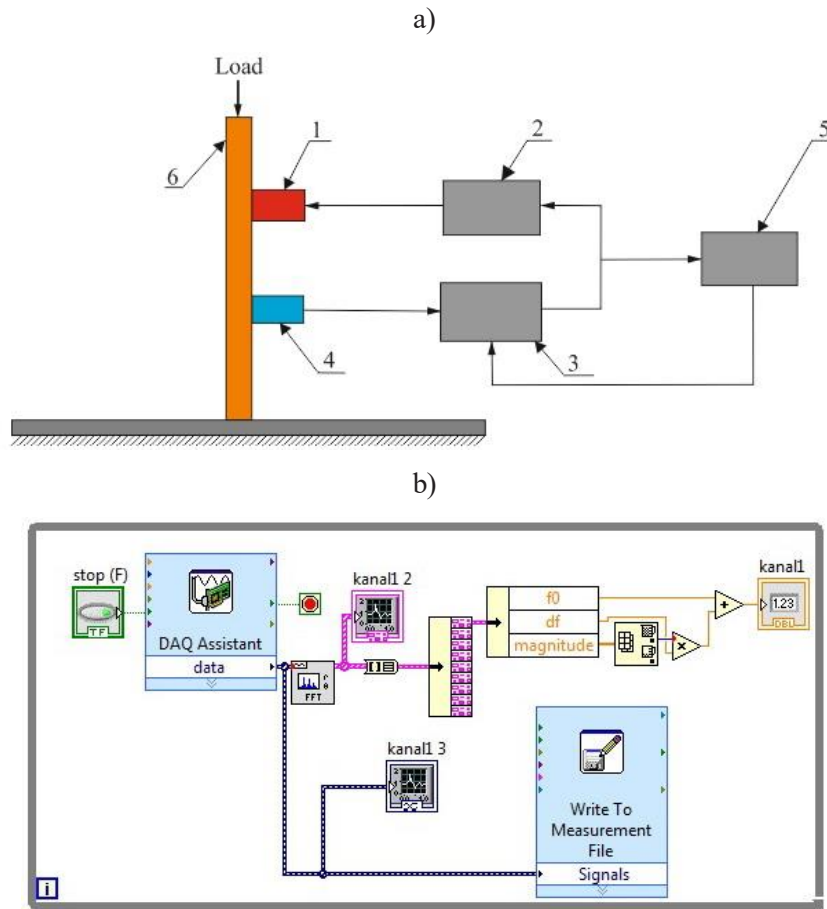

**Figure 3:** An example of SAS configuration; a) block diagram, 1 – acoustic-vibration transmitter; 2 – amplifier; 3 – conditioner; 4 – acoustic-vibration receiver; 5 – measurement and control block; 6 – monitored component; b) sensor configuration in the LabVIEW program.

$$\omega = \frac{1}{\tau T_0} \sqrt{\frac{\sqrt{T_0^4 + 2T_0^2\tau^2 + \tau^4 - 8\zeta T_0^3\tau - T_0^2 + \tau^2}}{2}} \quad (1)$$

where:  $\omega$  – is the pulsation of self-excited vibrations;  $T_0$  – time of natural vibrations of the component;  $\tau$  – delay due to wave propagation between the exciter and accelerometer (shells);  $\zeta$  – damping.

The relationship (1) indicates that the change in the rate of wave propagation, and – by extension – in the time of wave propagation between the transmission and reception head influences the frequency of the self-excited system. Moreover, the SAS has another advantage of featuring a positive feedback loop, allowing the frequencies of the measurement system to amount to several dozen kHz instead of MHz. In addition, the frequency measurement makes it possible to determine this delay with great precision, and ensures high noise immunity.

### 3 Laboratory tests

The laboratory tests of the expansion-shell bolt have been conducted on a modern test stand owned by the Department of Underground Mining of the AGH University of Science and Technology. The test stand can be used to test roof bolts on a geometric scale of 1:1 under static and rapidly varying loads. Also, the stand is suitable for testing rods measuring 5.5 m or 6 m in length after dismantling the lathe chuck from the test frame. The stand has a special feature of providing the ongoing monitoring of bolt load, displacement and deformation by displaying recorded data via CatmanEasy – the specialist measurement software.<sup>[8]</sup> The laboratory tests used expansion-shell bolts with a length of 1.82 m. The bolts comprised the KE-3W expansion shell, a rod with a diameter of 0.0183 m, and a profiled, circular plate with a diameter of 0.14 m and a gauge of 0.006 m. The roof bolts were installed in a concrete block with a compressive strength of 75 MPa. The concrete mix

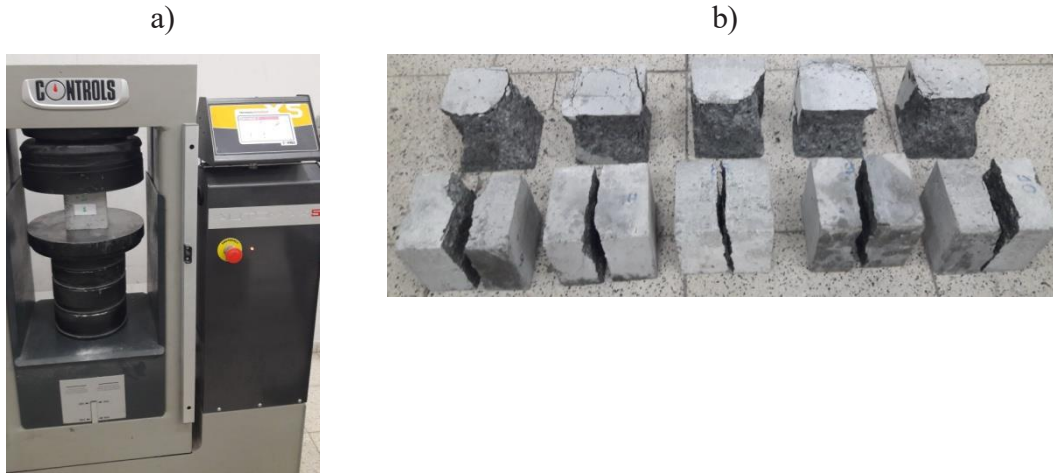

**Figure 4:** Strength tests of concrete cube specimens; a) the Controls Automax5 strength testing machine; b) specimens after compressive and tensile testing.

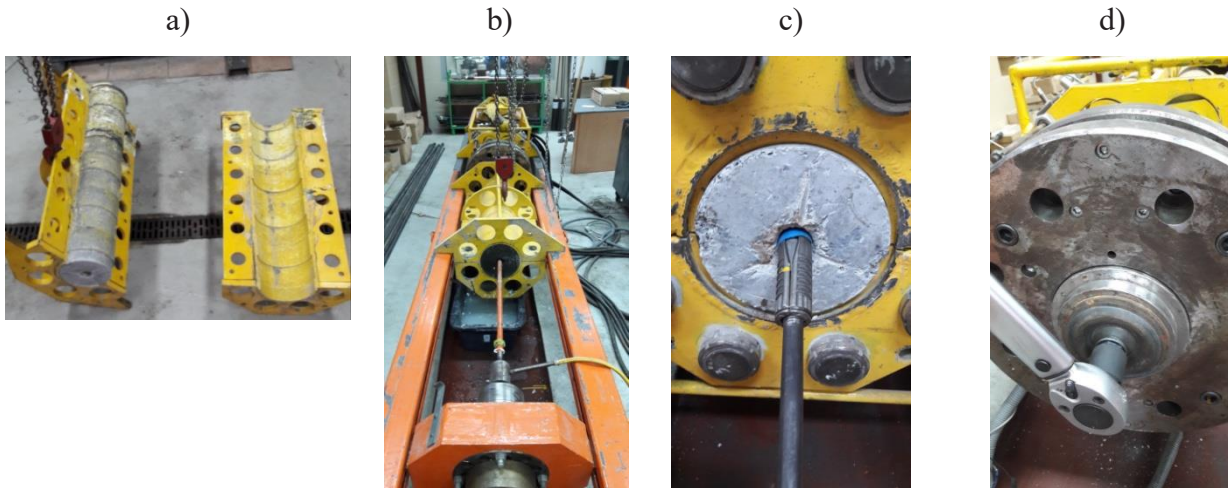

**Figure 5:** Test stand setup; a) split cylinder filled with concrete mix; b) concrete block drilling; c) inserting the KE-3W expansion shell into the concrete block; d) applying prestress with a torque wrench.

comprised sand graded 0–2 mm, Górażdże cement class 42.5 R, water, fumed silica (SikaFume-HR/-TU), diabase aggregate graded 2–2.5 mm and super plasticizer (Sika ViscoCrete-20HE). The tensile and compressive testing of a 0.1 m concrete cube specimen (Fig. 4b) was conducted using the Controls Automax5 strength testing machine (Fig. 4a) provided with Microdata Autodriver software. The compressive load rate was 0.6 MPa/s and the tensile load rate was 0.1 MPa/s.

Once the tests proved a satisfactory compressive strength within the range of 73–77 MPa and tensile strength (Brazilian test) within the range of 5.9–6.4 MPa, the split cylinders were filled with concrete mix (Fig. 5). Next, boreholes with a diameter of 0.037 m were drilled

in these cylinders using a drill bit. The drill bit rod was mounted to the lathe chuck of the movable crosshead on the test stand frame (Fig. 5b). The subsequent testing stage involved the installation of the expansion-shell bolt. The bolt was inserted manually to the concrete block (Fig. 5c). Next, a torque wrench (Fig. 5d) with a tightening torque of 250 Nm was used to apply a prestress within the range of 23 kN to 30 kN (Fig. 6).

Based on the resultant load and displacement behavior, the elastic deformation region of the expansion-shell bolt was estimated to end at about 105 kN. The determination of this value was very important for the safety of further laboratory tests using self-excited acoustic system (SAS) sensors (the handle with SAS sensors was mounted and

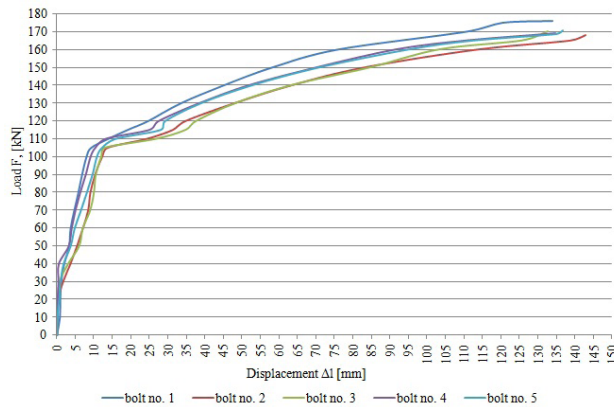

**Figure 6:** Load and displacement behavior of the KE-3W expansion-shell bolt.



**Figure 7:** Dismantled concrete block with fixed KE-3W shells after tensile testing.

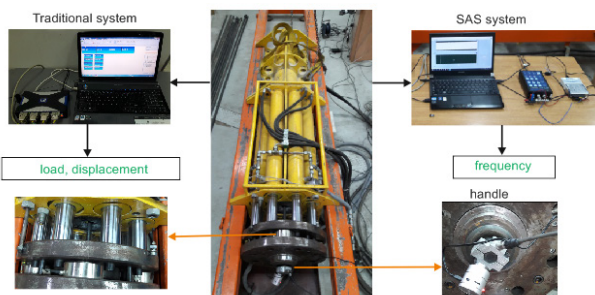

**Figure 8:** Measurement sensors of the traditional system and the SAS.

dismounted multiple times in order to corroborate the frequency results). The force range from 105 kN to 120 kN and the displacement in the range from 13 mm to 35 mm corresponds to the lower and upper yield strength. Above this range, significant increase in the length of the tested bolt is observed. The maximum loads were within the range of 165 kN to 168 kN. Each time, the material failed within the thread core diameter (Fig. 7).

### 3.1 Load, displacement and frequency behavior of an expansion-shell bolt

The primary aim of the study was to compare the results recorded by two different measurement systems (load and displacement) with the innovative Self-Excited Acoustic System (SAS) for measuring stress variations in a roof bolt (Fig. 8). In order to use the SAS, a special handle equipped with an accelerometer and exciter mounted to the nut or the upset end of the rod was designed at the Faculties of Mining and Geoengineering and Mechanical Engineering and Robotics of the AGH University of Science and Technology. The handle comprises two regular pieces connected by two Allen head bolts. The accelerometer was screwed to one piece of the handle, while the other piece featured a screw pocket to fix the exciter. It takes several seconds to mount the handle on the nut or the upset end of the rod. More or less the same amount of time is needed to read the frequencies on the portable measurement device (a laptop with LabVIEW software, a conditioner, and a DAQ card). The measurement results for load – frequency and displacement – frequency are shown in Figures 9 and 10, respectively.

In Figure 9, the frequency in range I is from 4,220 Hz to 4,290 Hz, corresponding to a prestress of 25 kN to 30 kN. Range II, from 4,834 Hz to 4,912 Hz, corresponds to a limit value of the elastic deformation region of 100 kN to 105 kN. In Figure 10, a frequency within the range of 4,220 to 4,290 Hz corresponds to a bolt deformation of 0.4 mm to 1.6 mm. A frequency within the range of 4,834 Hz to 4,912 Hz corresponds to a bolt deformation of 9.7 mm to 13 mm. In figure 9 the function,  $F = f(f)$  is almost linear over the entire range ( $> 4075$  Hz). To specify the lower yield point, the range 100 ÷ 105 kN was chosen. In Figure 10, the function  $\Delta l = f(f)$  is nonlinear in the whole range. The range between 4,250–4,800 Hz can be considered as quasi-linear. This is the result of the clamping force of the SAS system on the end of the rock bolt. From the value of  $\Delta l = 9$  mm, the characteristic curve goes up vertically, which means that there has been a change in the frequency of self-excited vibrations. On the basis of Figures 9 and 10, it can be assumed that the function  $F = f(f)$  is qasi-linear, and  $\Delta l = f(f)$  – nonlinear (or significantly nonlinear) with the range of linear behaviors.

## 4 Conclusions

This paper discusses the static tensile tests of a roof bolt using the innovative Self-Excited Acoustic System (SAS). The test stand of the Department of Underground Mining

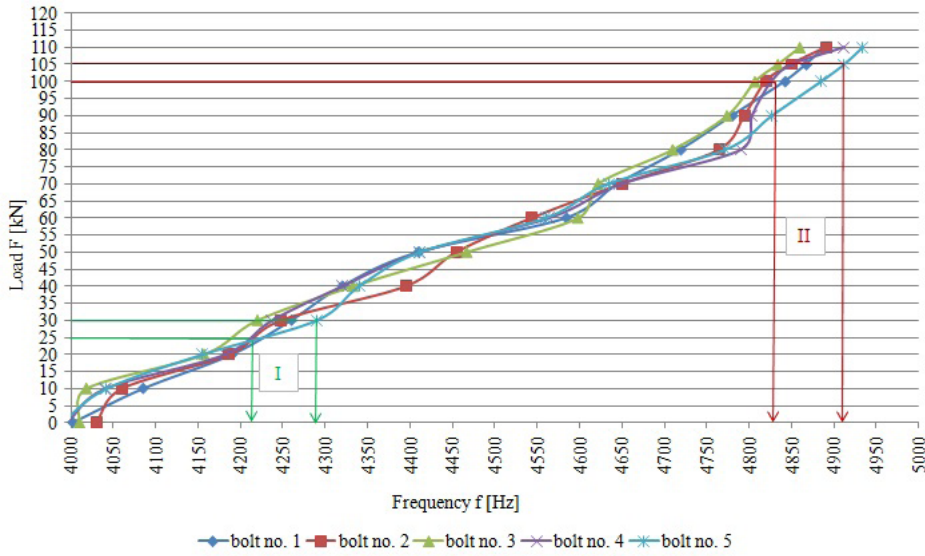

Figure 9: Load and frequency behavior of the expansion-shell bolt with a length of 1.82 m.

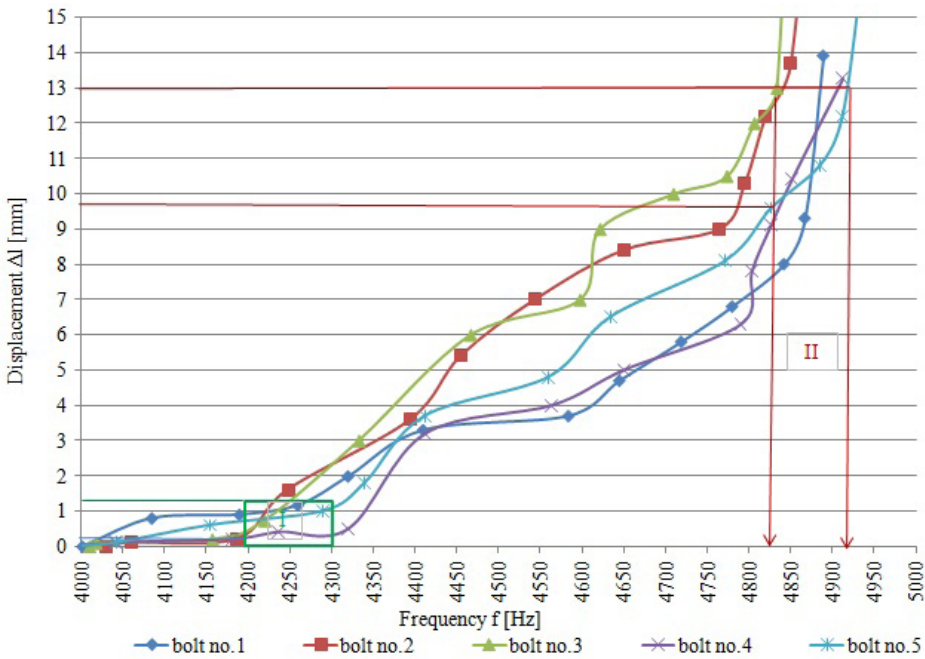

Figure 10: Displacement and frequency behavior of the expansion-shell bolt with a length of 1.82 m.

on which the tensile testing of the expansion-shell bolt was performed perfectly reflects the mining conditions, thanks to a number of advantages such as the possibility of testing bolts on a scale of 1:1 with rod lengths of up to 6 m and a load range up to 1600 kN. Although the measurement does not take much time, the sensor requires pre-calibration. Through laboratory calibration tests, roof bolt loads can be assessed using the in-situ non-destructive method. Once the load and frequency and displacement

and frequency behavior curves (Fig. 9 and Fig. 10) are determined, the roof bolt load and displacement can be measured in a matter of seconds. Based on the load and frequency and displacement and frequency behaviors, specific frequency ranges can be determined for range I, meaning the prestress, and range II, relating to the limit value of the elastic deformation region (Fig. 9 and 10). In the underground workings of KGHM Polska Miedź S.A., within the area of the Legnica-Głogów Copper District,

around 2.5 millions roof bolts are used each year. Rock bolts are the fundamental form of supporting the excavation in the room and pillar mining systems. Within these systems, bolts are installed manually and for the most part using self-propelled bolting cars. Rooms must be supported very quickly. Bearing in mind that the monitoring of the rock bolt support is a time-consuming process, the authors of the article proposed a new method that is fast and easy to use. Furthermore, the Self-Excited Acoustic System (SAS) can be used for non-destructive evaluation of strength utilization of bolts around workings and in tunnels.

*This paper was written under grant entitled 'The Self-Excited Acoustic System (SAS) for Monitoring Safety Levels in Mine Workings.' Agreement No. TANGO2/340166/NCBR/2017.*

## 5 Literature

- [1] Adach-Pawelus, K., Butra, J. & Pawelus, D. (2017). An Attempt at Evaluation of the Remnant Influence On the Occurrence of Seismic Phenomena in a Room-and-Pillar Mining System with Roof Deflection. *Studia Geotechnica et Mechanica*. 39(2), 3-16. Retrieved August 1, 2017, from Walter de Gruyter GmbH: <http://sgem.pwr.wroc.pl>. DOI: 10.1515/sgem-2017-0011.
- [2] Burtan, Z., Zorychta, A., Cieřlik, J. & Chlebowski, D. (2014). Influence of mining operating conditions on fault behavior. *Archives of Mining Science*. 59(3), 691-704. DOI: doi.org/10.2478/amsc-2014-0048.
- [3] Chlebowski, D., Burtan, Z. & Zorychta, A. (2018). Evaluation of rockburst hazard under abandoned mine workings. *Archives of Mining Science*. 63(3), 687-699. Retrieved October 1, 2018, from Instytut Mechaniki Górotworu PAN: <http://mining.archives.pl>. DOI: 10.24425/123691.
- [4] Dębkowski, R., Madziarz, M., Sawicki, W. & Osadczyk, T. (2007). Measurements of load acting on expansive roof bolts affected by seismic events. *Rudy i Metale Nieżelazne*. 52(8), 459-463.
- [5] Fuławka, K., Mertuszka, P. & Pytel, W. (2018). Monitoring of the stability of underground workings in Polish copper mines conditions. *E3S Web of Conferences*. 29, 1-14. Retrieved January 31, 2018, from EDP Sciences: <http://www.e3s-conferences.org>. DOI: 10.1051/e3sconf/20182900008.
- [6] Ivanović, A. & Neilson, R.D. (2013). Non-destructive testing of rock bolts for estimating total bolt length. *International Journal of Rock Mechanics and Mining Sciences*. 64, 36-43. DOI: 10.1016/j.ijrmms.2013.08.017.
- [7] Kapusta, M. (2017). Wpływ osób dozoru górniczego na poprawę warunków bhp. *Inżynieria Mineralna*. 18(2), 183-193. DOI: 10.29227/IM-2017-02-20.
- [8] Korzeniowski, W., Skrzypkowski, K. & Herezy, Ł. (2015). Laboratory method for evaluating the characteristics of expansion rock bolts subjected to axial tension. *Archives of Mining Science*. 60(1), 209 - 224. DOI: 10.1515/amsc-2015-0014.
- [9] Korzeniowski, W., Skrzypkowski, K. & Herezy Ł. (2018). Zdalny, nieelektryczny wskaźnik WK-2/8 wartości siły obciążającej kotew w wyrobisku górniczym. *Zeszyty Naukowe Instytutu Gospodarki Surowcami Mineralnymi i Energią Polskiej Akademii Nauk*. 103, 53-64. DOI: 10.24425/123706.
- [10] Korzeniowski, W., Skrzypkowski, K. & Zagórski, K. (2017). Reinforcement of underground excavation with expansion shell rock bolt equipped with deformable component. *Studia Geotechnica et Mechanica*. 39(1), 39-52. Retrieved May 17, 2017, from Walter de Gruyter GmbH: <http://sgem.pwr.wroc.pl>. DOI: 0.1515/sgem-2017-0004.
- [11] Korzeniowski, W., Skrzypkowski, K., Herezy, Ł., Kulik, M. & Zagórski K. (2016). Patent RP nr PAT.226879. Sposób pomiaru obciążenia kotwy oraz dynamometryczna podkładka kotwowa. Akademia Górniczo-Hutnicza, Kraków. Biuletyn Urzędu Patentowego.
- [12] Kwaśniewski, J., Dominik, I., Konieczny, J. & Lalik K. (2014). Patent RP nr 219351. Urządzenie do monitorowania zmian naprężeń. Akademia Górniczo-Hutnicza, Kraków. Biuletyn Urzędu Patentowego.
- [13] Kwaśniewski, J., Dominik I., Lalik K., Korzeniowski W., Zagórski K. & Skrzypkowski K. (2016). Rock bolts health monitoring using self-excited phenomenon. *Diffusion and Defect Data – Solid State Data. Part B, Solid State Phenomena*. 248, 186–191. DOI: 10.4028/www.scientific.net/SSP.248.186.
- [14] Małkowski, P., Ostrowski, Ł. & Bochenek, P. (2017). Modelling the Small Throw Fault Effect on the Stability of a Mining Roadway and Its Verification by In Situ Investigation. *Energies*. 10,1-21. Retrieved December 7, 2017, from MDPI - Publisher of Open Access Journals: <http://www.mdpi.com>. DOI: 10.3390/en10122082.
- [15] Niedbalski, Z., Małkowski, P. & Majcherczyk, T. (2013). Monitoring of stand-and-roof-bolting support: design optimization. *Acta Geodynamica and Geomaterialia*. 10( 2), 215–226.
- [16] Prusek, S., Turek, M., Rotkegel, M. & Witek, M. (2012). Wybrane rozwiązania konstrukcyjne wskaźników obciążenia kotwi. *Przegląd Górniczy*. 5, 37-44.
- [17] Pytlík, A. & Pytlík, M. (2016). Czujniki do monitoring siły naciągu kotwi górniczych przy obciążeniach statycznych i dynamicznych. *Przegląd Górniczy*. 11, 38-47.
- [18] Pytlík, A., Prusek S. & Masny, W. (2016). A methodology for laboratory testing of rockbolts used in underground mines under dynamic loading conditions. *Journal of the Southern African Institute of Mining and Metallurgy*. 116(12), 1101-1110. DOI: 0.17159/2411-9717/2016/v116n12a2.
- [19] Skrzypkowski, K. (2018). A new design of support for bust-prone rock mass in underground ore mining. *E3S Web of Conferences*. 71, 1-9. Retrieved December 5, 2018, from EDP Sciences: <http://www.e3s-conferences.org>. DOI: 10.1051/e3sconf/20187100006.
- [20] Skrzypkowski K. (2018). Evaluation of rock bolt support for Polish hard rock mines. *E3S Web of Conferences*. 35, 1-8. Retrieved March 23, 2018, from EDP Sciences: <http://www.e3s-conferences.org>. DOI: 10.1051/e3sconf/20183501006.
- [21] Skrzypkowski, K. (2018). Laboratory testing of a long expansion rock bolt support for energy-absorbing applications. *E3S Web of Conferences*. 29, 1-9. Retrieved January 31, 2018, from EDP Sciences: <http://www.e3s-conferences.org>. DOI: 10.1051/e3sconf/20182900004.



- [22] Skrzypkowski, K., Korzeniowski, W., Zagórski, K. & Dudek, P. (2017). Application of long expansion rock bolt support in the underground mines of Legnica-Głogów copper district. *Studia Geotechnica et Mechanica*. 39(3), 47-56. Retrieved November 18, 2017, from Walter de Gruyter GmbH: <http://sgem.pwr.wroc.pl>. DOI: 10.1515/sgem-2017-0029.
- [23] Song, G., Li, W., Wang, B. & Ho, S.C.M. (2017). A Review of Rock Bolt Monitoring Using Smart Sensors. *Sensors*. 17(4), 1-24. Retrieved April 5, 2017, from MDPI - Publisher of Open Access Journals: <http://www.mdpi.com>. DOI: 10.3390/s17040776.
- [24] Staniek, A. (2005). Method for identification of grouting continuity of rock bolts. *Archives of Mining Sciences*. 50(3), 371-396.
- [25] Tajduś, A., Cała, M., Tajduś, K. (2018). *Seismicity* and rock burst hazard assessment in fault zones: a case study. *Archives of Mining Sciences*. 63(3), 747-765. Retrieved October 1, 2018, from Instytut Mechaniki Górotworu PAN: <http://mining.archives.pl>. DOI: 10.24425/123695.