

R 96
m

Archiwum



PUBLICATION INDUSTRIELLE
DES
MACHINES, OUTILS ET APPAREILS

LES PLUS PERFECTIONNÉS ET LES PLUS RÉCENTS

EMPLOYÉS

DANS LES DIFFÉRENTES BRANCHES DE L'INDUSTRIE FRANÇAISE ET ÉTRANGÈRE

PAR

ARMENGAUD AINÉ

INGÉNIEUR, PROFESSEUR AU CONSERVATOIRE IMPÉRIAL DES ARTS ET MÉTIERS
MEMBRE DE LA SOCIÉTÉ D'ENCOURAGEMENT ET DE LA SOCIÉTÉ INDUSTRIELLE DE MULHOUSE

TOME HUITIÈME

PLANCHES

1912. 499.

PARIS

CHEZ L'AUTEUR, 45 RUE SAINT-SÉBASTIEN

CHEZ M. CARILIAN-GOEURY ET VICTOR DALMONT

LIBRAIRES POUR L'INDUSTRIE, LES ARTS ET LES SCIENCES, 49, QUAI DES AUGUSTINS

A LA LIBRAIRIE SCIENTIFIQUE INDUSTRIELLE DE L. MATHIAS, 15, QUAI MALAQUAIS

ET CHEZ LES PRINCIPAUX LIBRAIRES

1853



TABLE DES PLANCHES

DU TOME HUITIÈME DE LA PUBLICATION INDUSTRIELLE

PLANCHES.	1 ^{re} LIVRAISON	PAGES.
1	Treuil et moulins à tabac, par M. RUDLER.	12
2	{ Turbines hydrauliques perfectionnées, par M. KRAFFT.	21
	{ Tiroirs équilibrés à sortie directe.	18
3	Proportions des boulons, des écrous et des filets de vis.	30
4	Machine locomotive à quatre roues couplées, par M. POLONCEAU. . .	54

2^e LIVRAISON

5	Machine locomotive par M. POLONCEAU. (<i>Suite.</i>)	54
6	{ Presse hydraulique à décaler les roues.	70
	{ Machine à essayer les ressorts.	73
7	Ensemble d'une fabrique de chocolat, par M. HERMANN.	85
8	Électromoteurs circulaire et épicycloïdal, par M. FROMENT.	107

3^e LIVRAISON

9	Télégraphe électrique écrivant, par M. FROMENT.	129
10	{ Ponts en fer et en fonte, par MM. PASTOR et BRIALMONT.	149
11		
12	Types et proportions des tôles et rivets pour chaudières.	178

4^e LIVRAISON

13	Moulin à vent de trois paires de meules, par M. HERPIN.	192
14	Machine à imprimer les étoffes, par MM. TROUBLE et LEBASTIER. . . .	211
15	Outillage des ateliers. — Divers systèmes de filières.	221
16	Machine soufflante horizontale, par M. CADIAT.	231

5^e LIVRAISON

17	Soufflerie horizontale de MM. THOMAS et LAURENS	248
18	Appareil à chauffer l'air avec les gaz perdus, par les mêmes.	260
19	Construction des machines. — Proportions des manivelles.	264
20	Métier mécanique à tisser, par M. de BERGUE.	280

PLANCHES.	6 ^e LIVRAISON	PAGES.
21	Machine à aléser, par M. MESMER.	287
22	Machine à plier et à coller les enveloppes, par M. LEGRAND.	296
23	Métier mécanique à tisser les rubans, par M. DIODONNAT.	300
24	Construction des machines. — Proportions des bielles en fer. . . .	304

7^e LIVRAISON

25	Construction des machines. — Proportions des bielles en fonte. . . .	321
26	Machine à forger, par M. RIDER. — Machine à rayer les canons de carabines.	331
27	Régulateurs de moteurs.	340
28	Métier à tulle, par M. KEENAN.	362

8^e LIVRAISON

29	Métier à tulle de M. KEENAN. (<i>Suite.</i>)	362
30	Appareil pour le nettoyage des blés, par M. BARON.	369
31	Tour et machine à fraiser de GRAFFENSTADEN.	375
32	Four à réchauffer alimenté par les flammes des feux d'affinerie, par M. KARR.	379

9^e LIVRAISON

33	{ Fabrication de la monnaie. — Fours, creusets et lingotières. — Laminaires dégrossisseur et polisseur.	409
34		
35	Construction des machines. — Proportions des balanciers.	428
36	Machine à peigner le lin, à peignes excentriques, par M. MARSDEN. . .	449

10^e LIVRAISON

37	Suite de la machine à peignes excentriques de M. MARSDEN.	449
38	Peigneuse circulaire à pinces tournantes, par le même.	462
39	Wagon pour le transport des chevaux, par M. DESGRANGES.	487
40	Perfectionnements aux métiers à la Jacquard, par MM. COUPLÉ et CARRÉ.	500

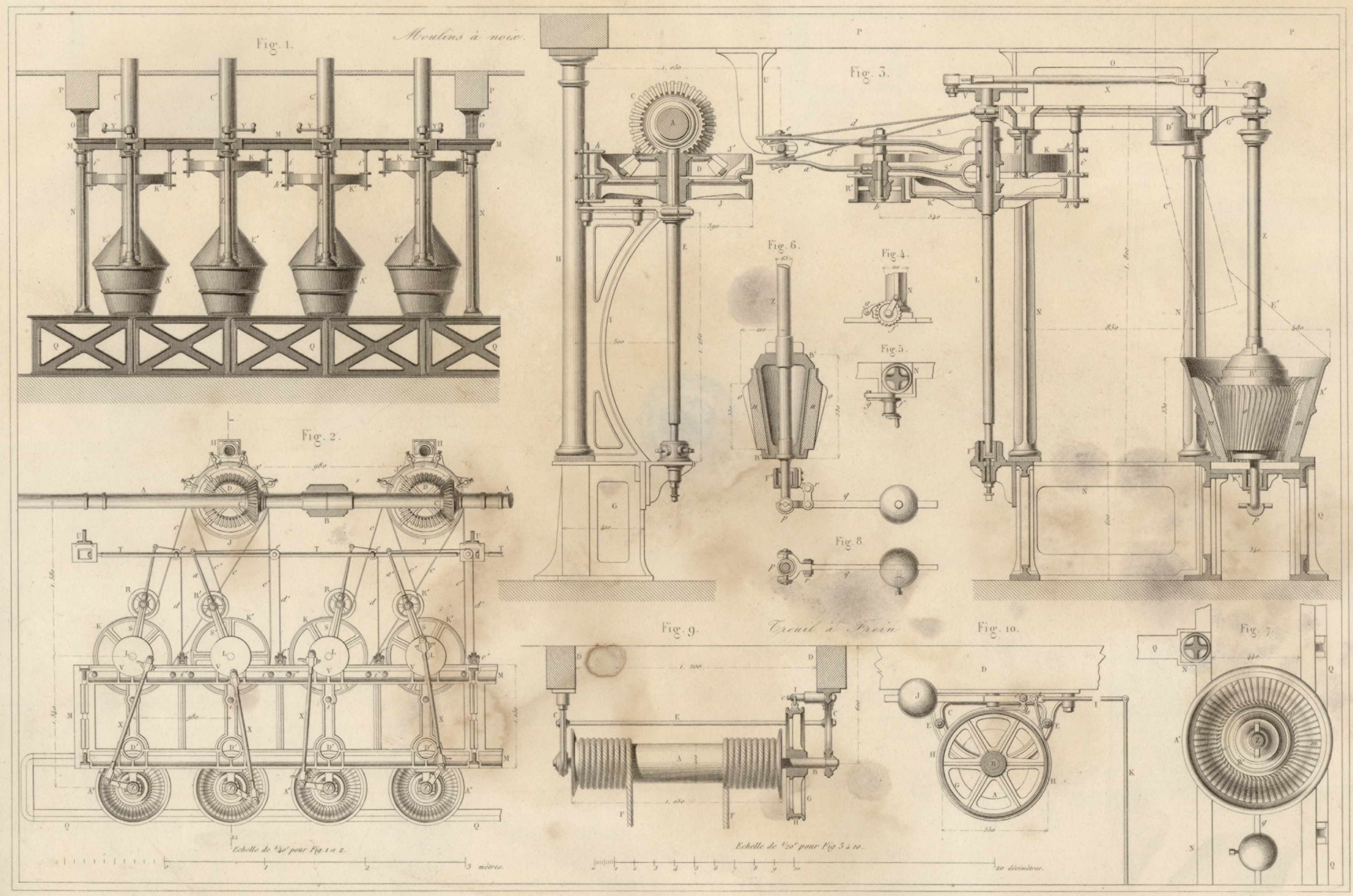

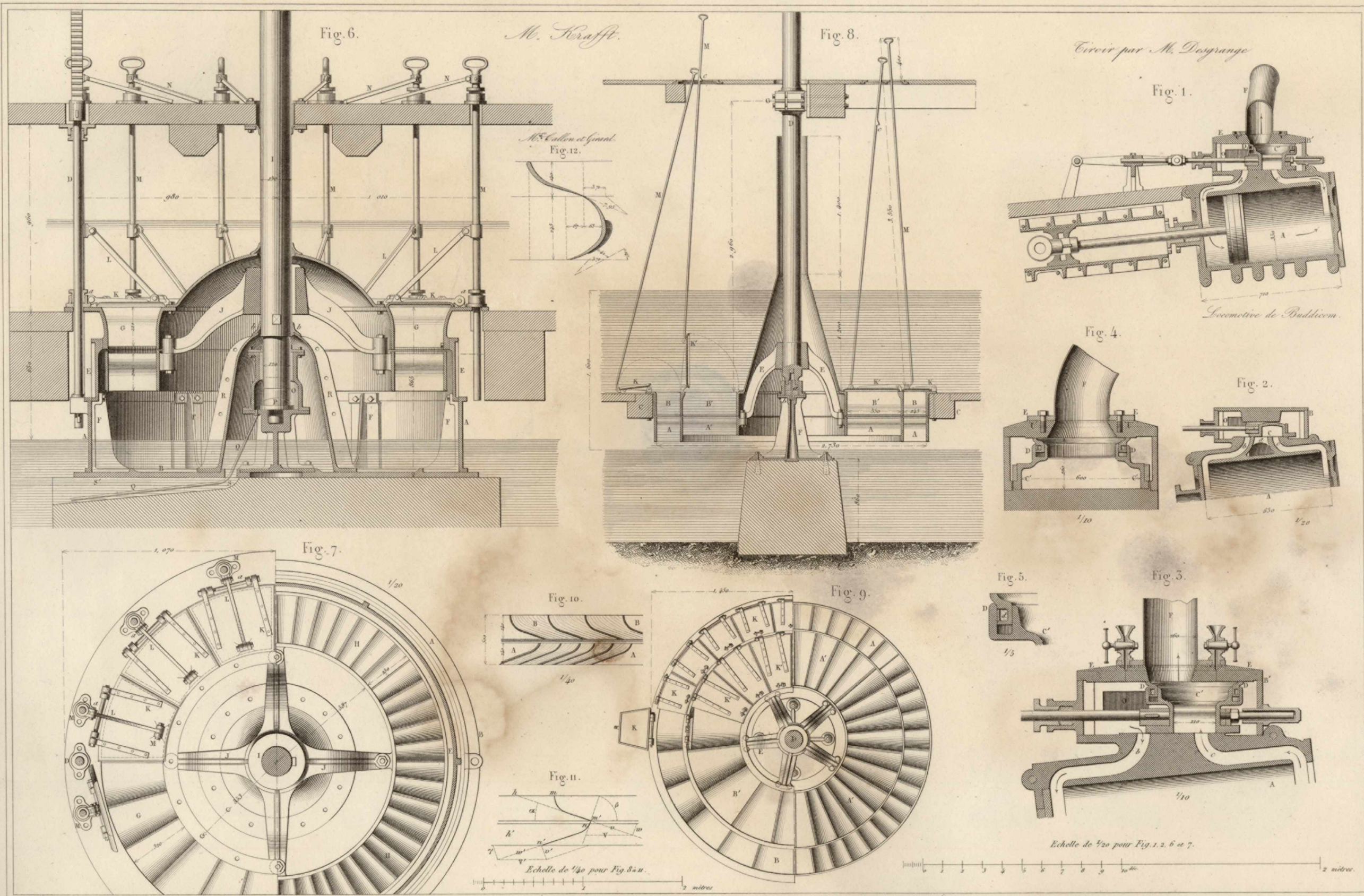

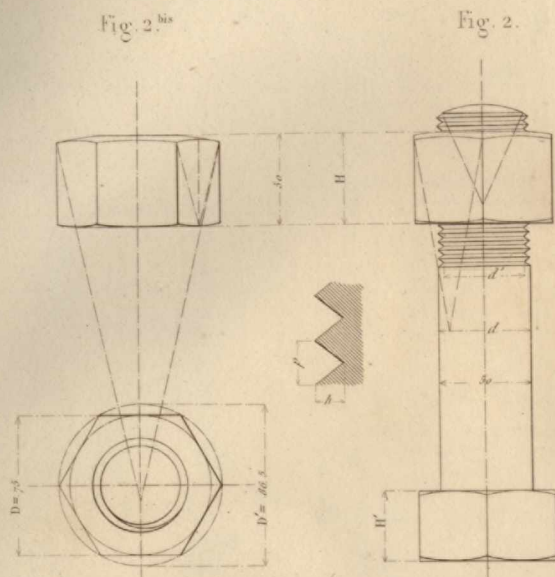

Formules $d = \frac{10}{9} \sqrt{P}$

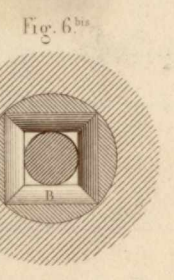
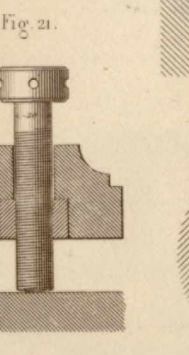
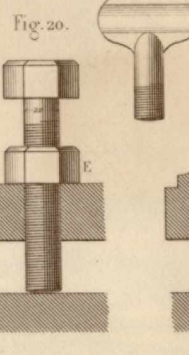
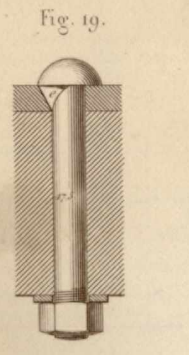
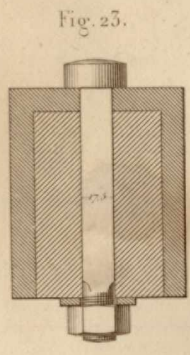
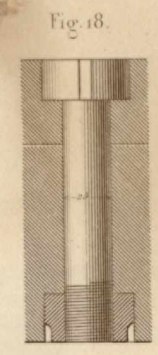
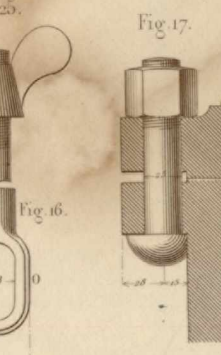
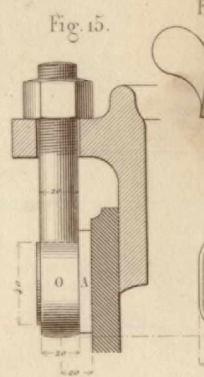
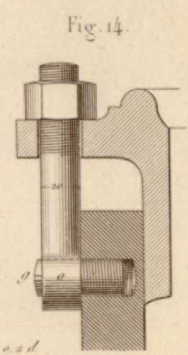
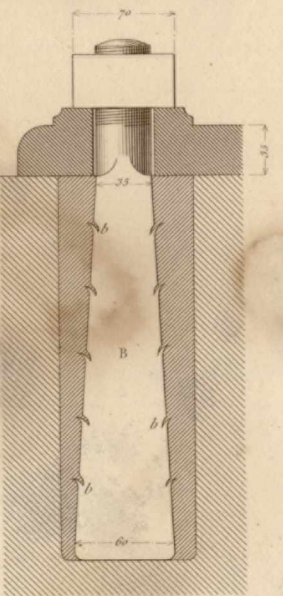
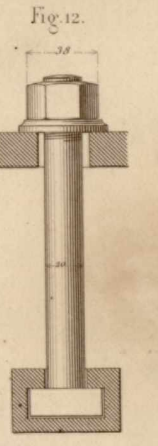
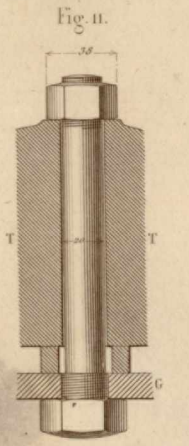
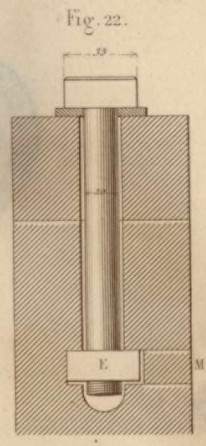
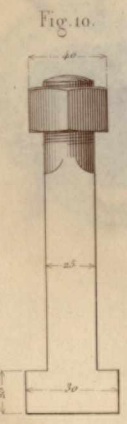
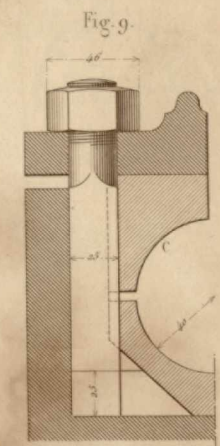
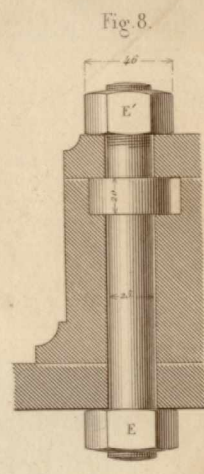
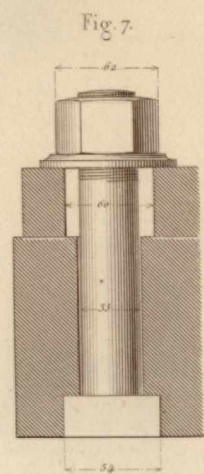
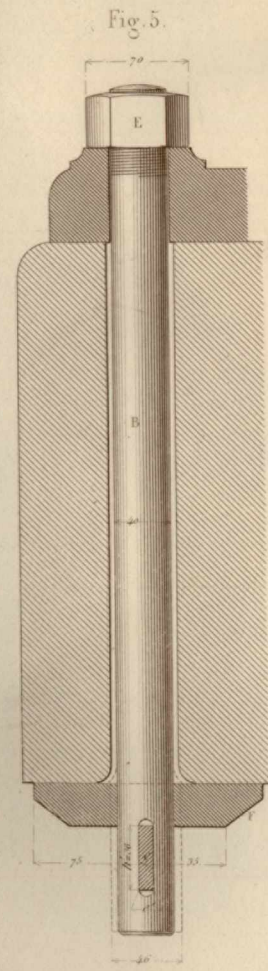
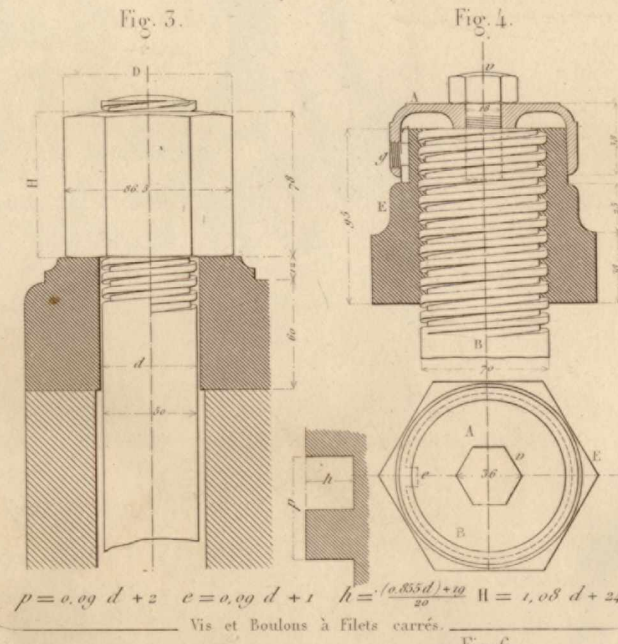
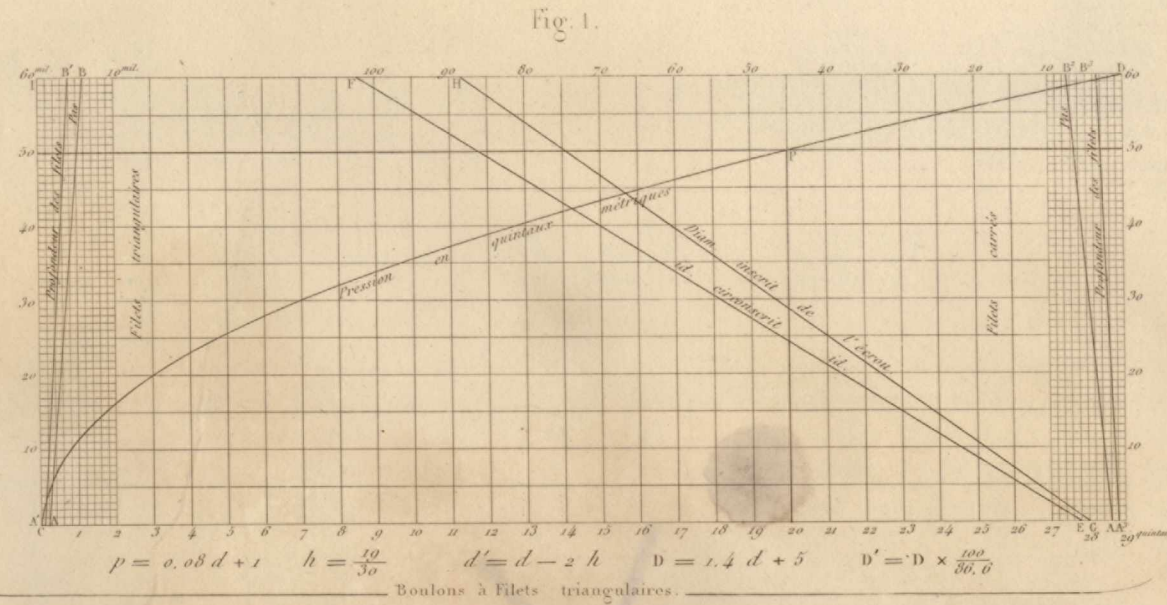

e' = 0.3 d
k = 0.9 d

Pour les Echelles voir les cotes.

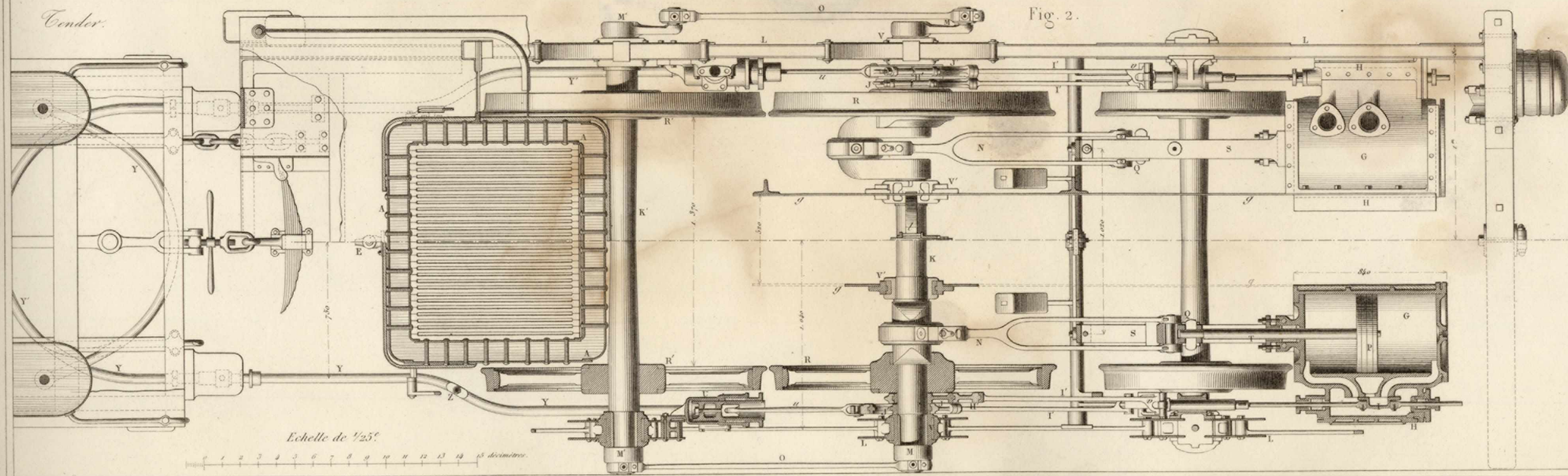
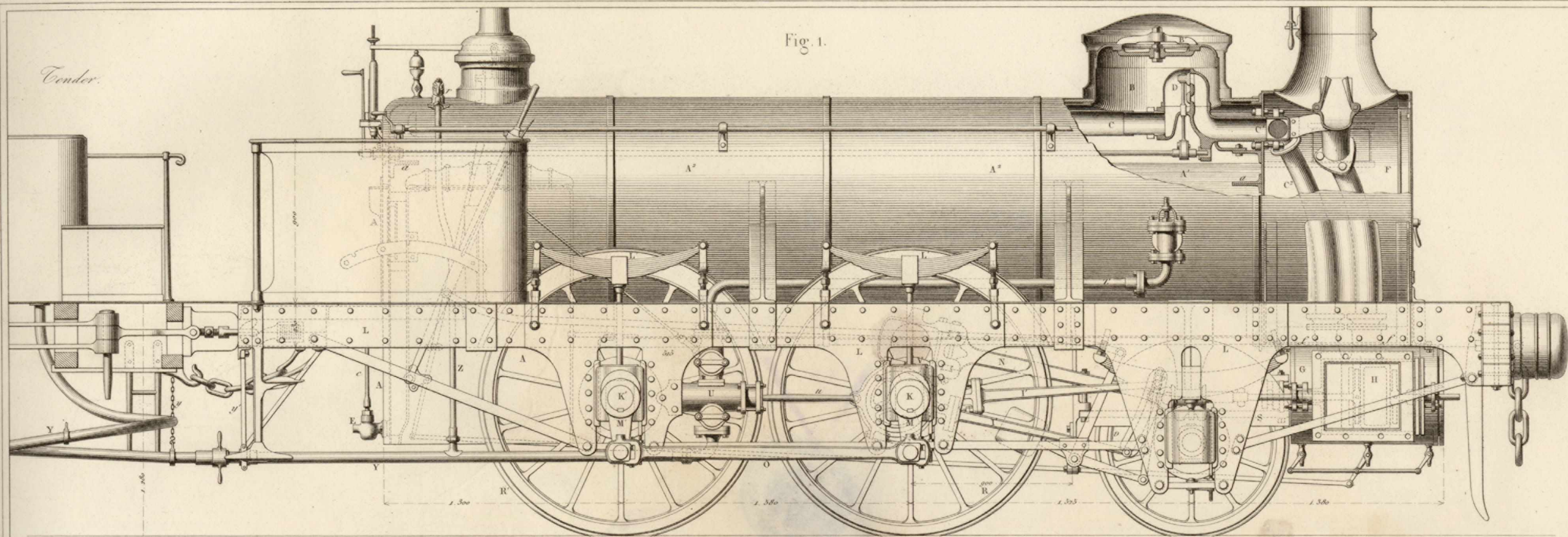

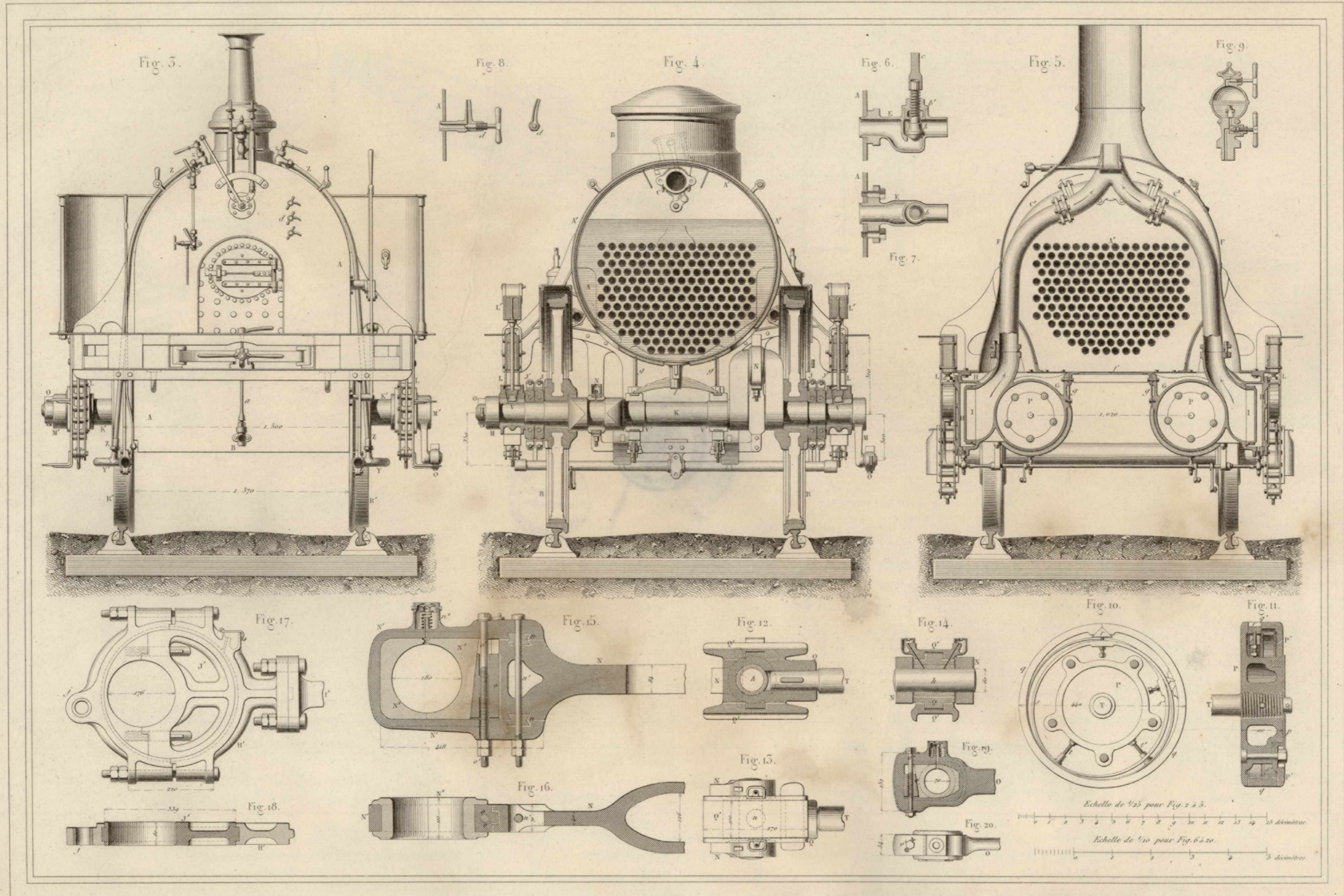

Presse et Grue.
par M. M. Schelin & C^{ie}

Balance et Vis.
par M. Mesmer.

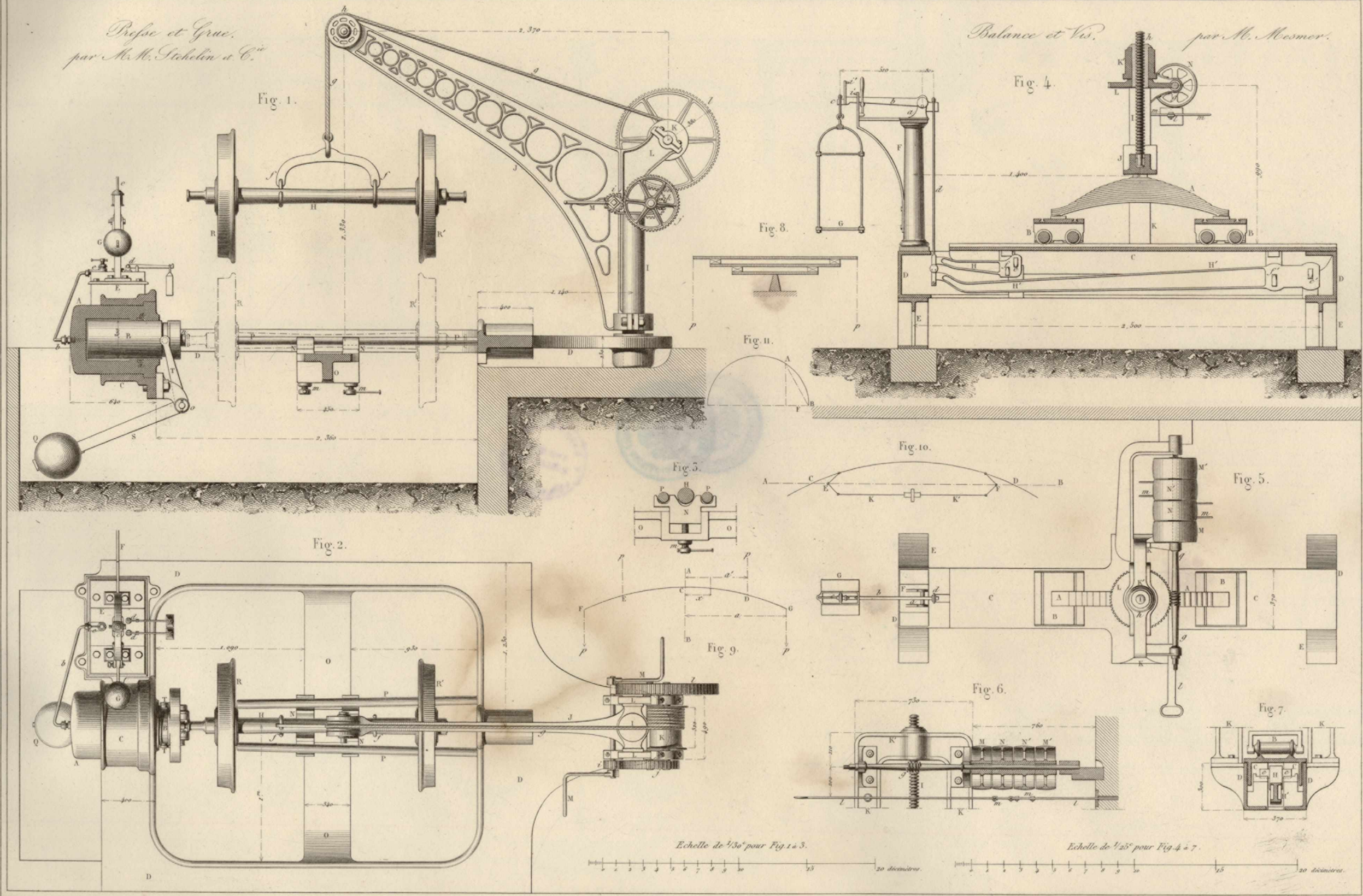

Echelle de 1/30^e pour Fig. 1 à 3.

Echelle de 1/25^e pour Fig. 4 à 7.

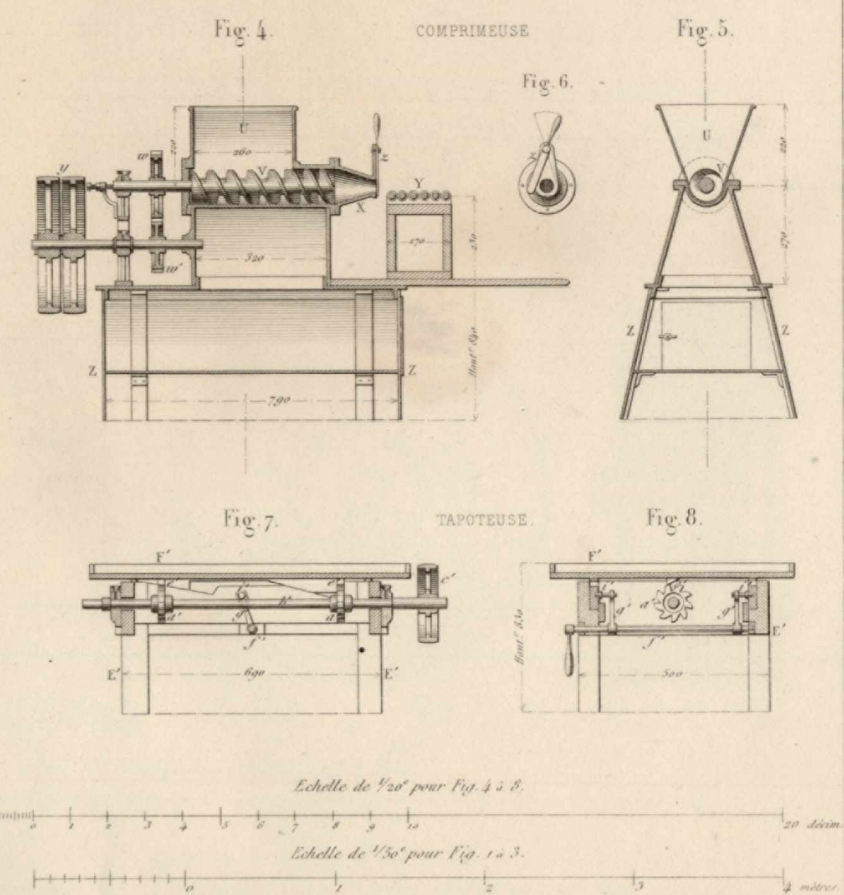
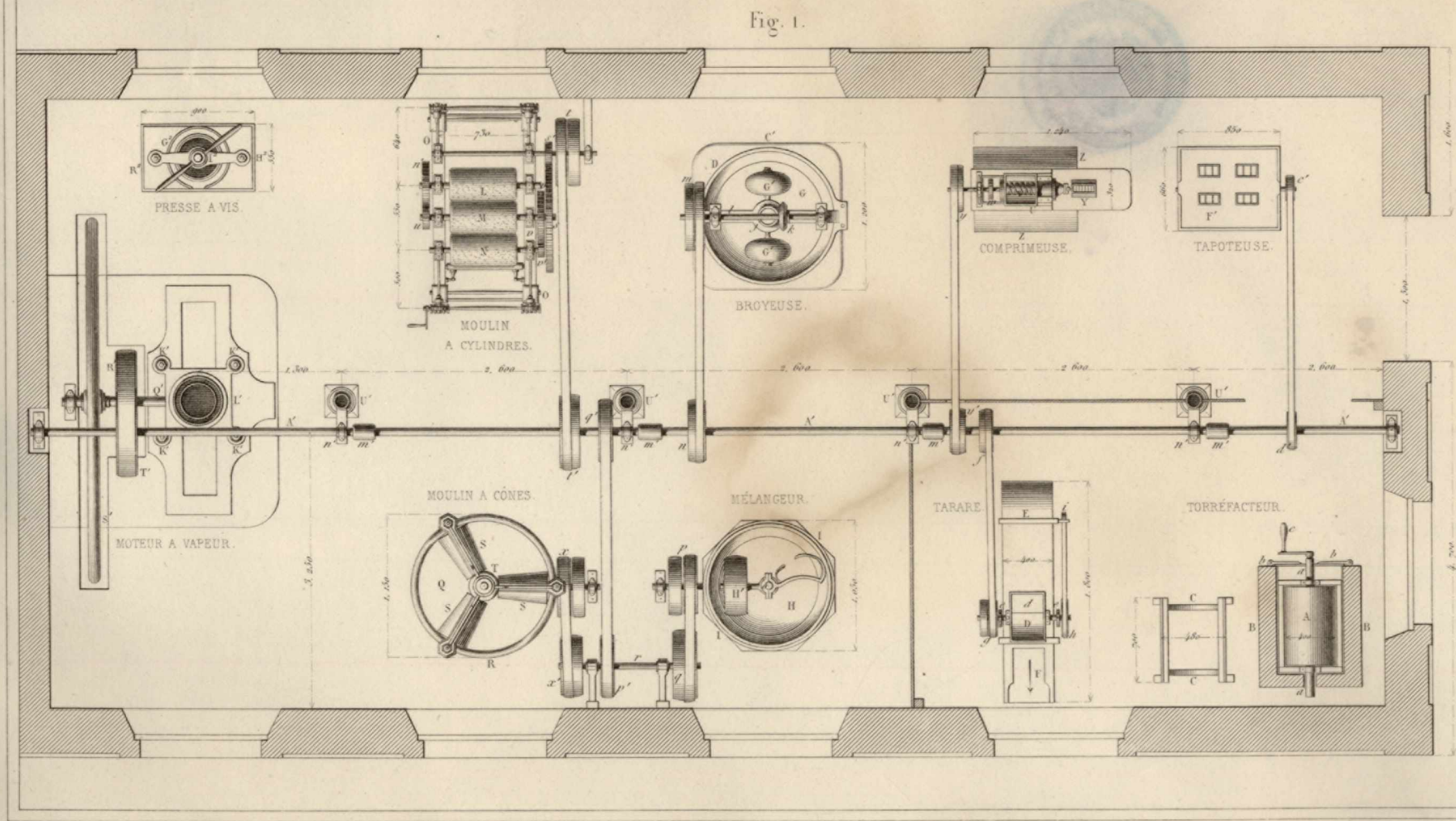
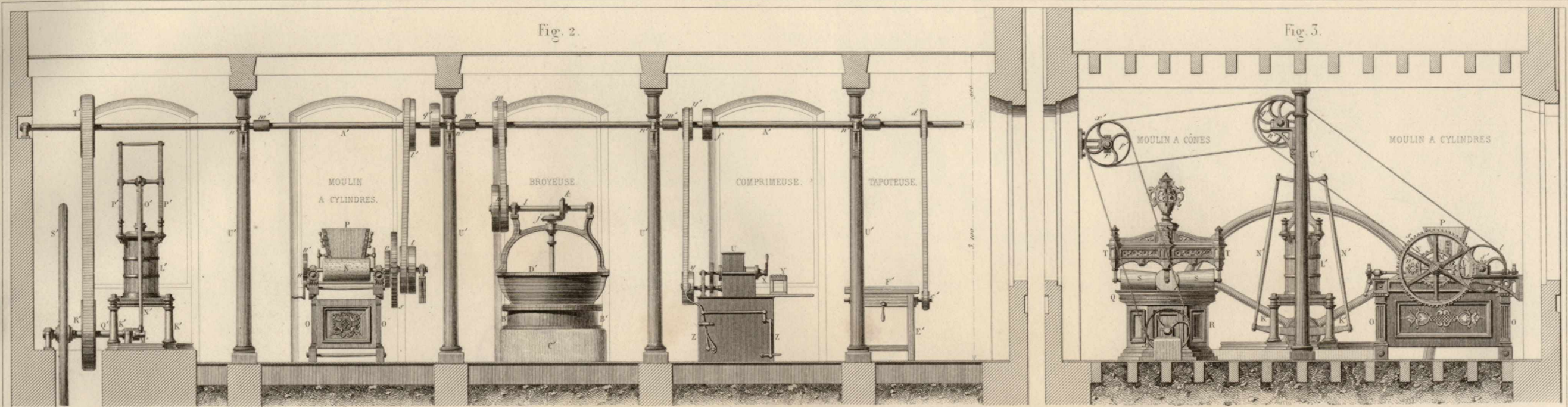

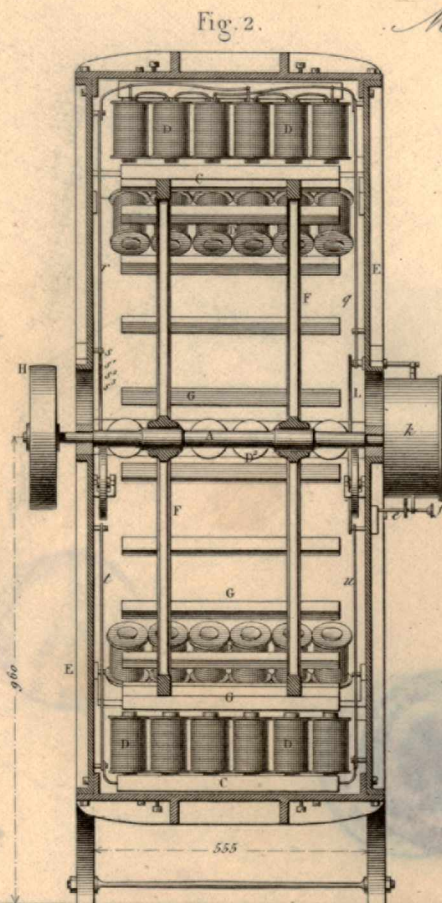
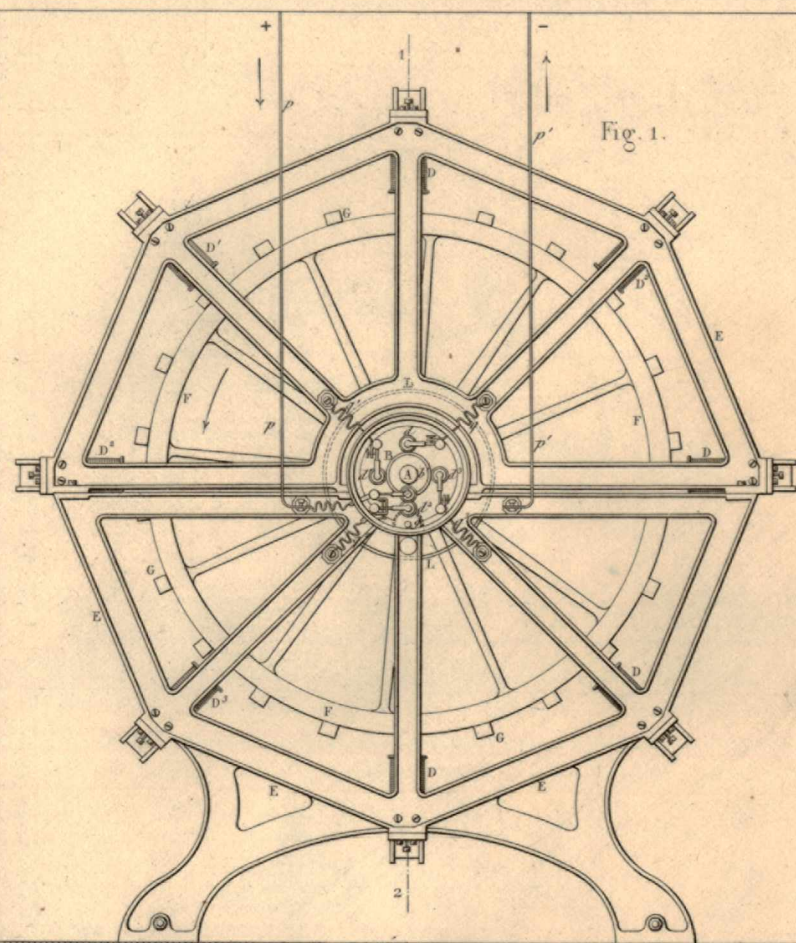

Moteur circulaire.

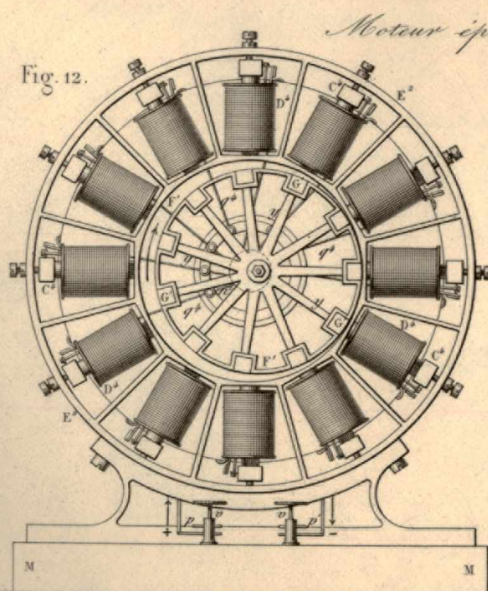
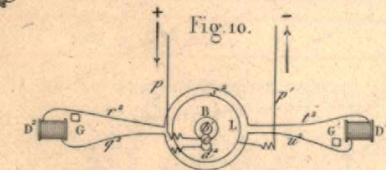
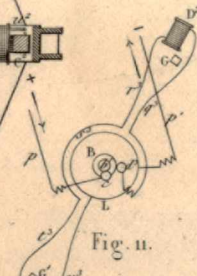
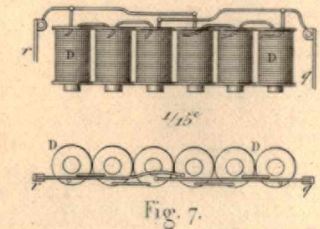
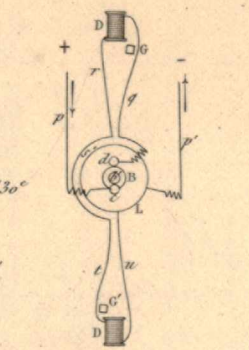
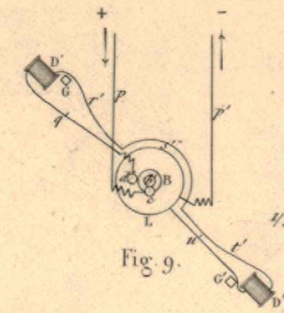
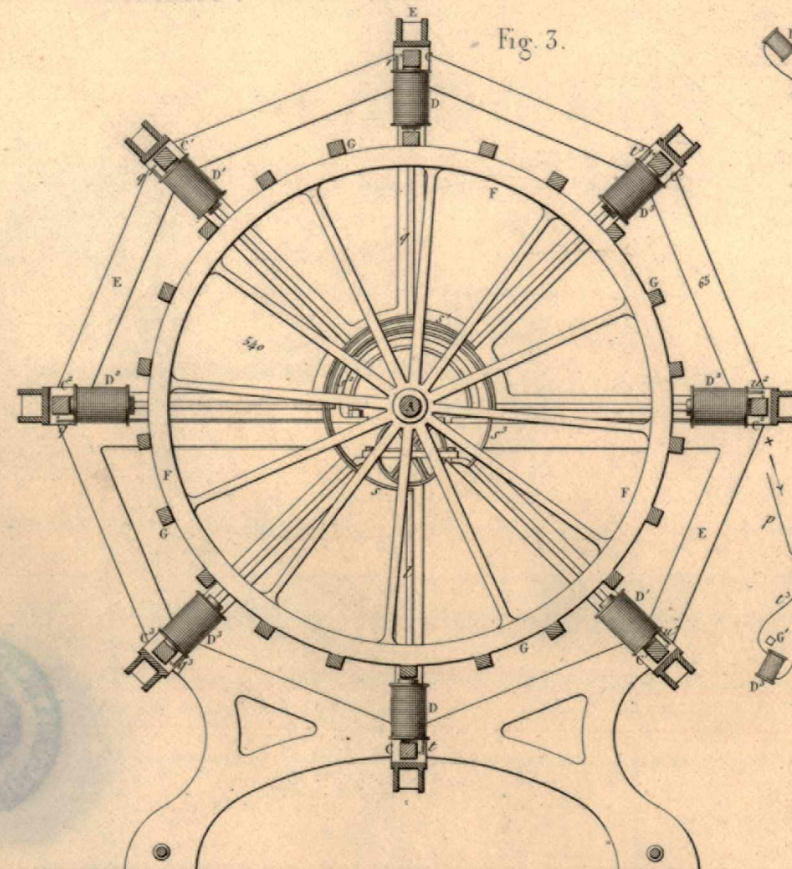

Moteur épicycloïdal.

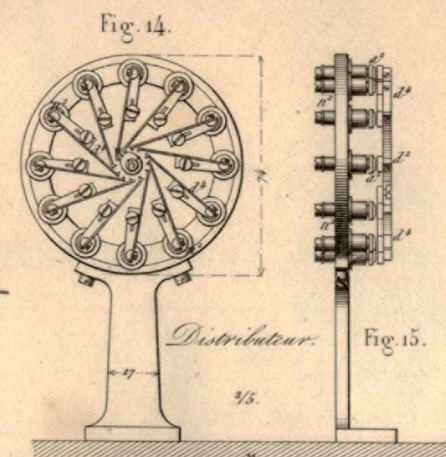
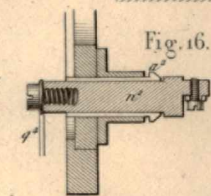
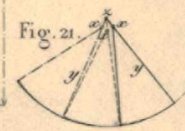
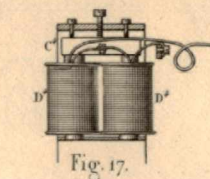
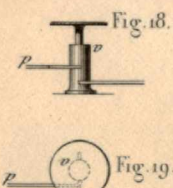
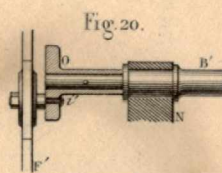
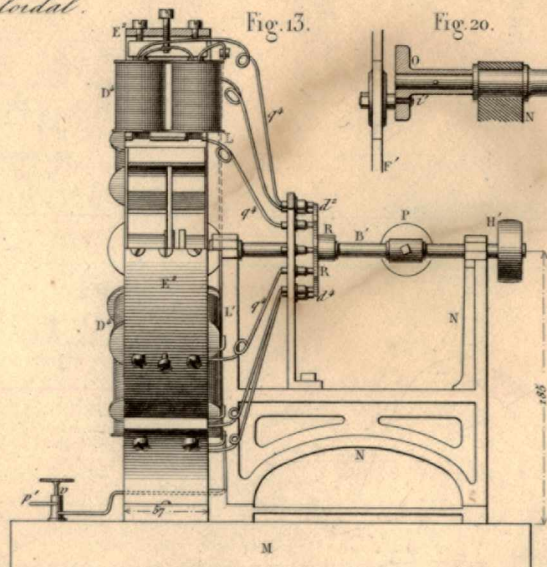

Distributeur.

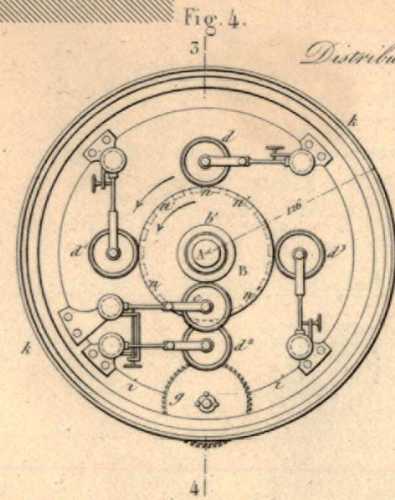
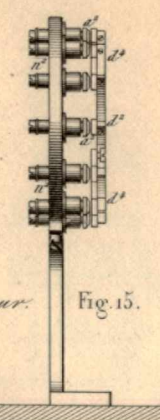

Distributeur.

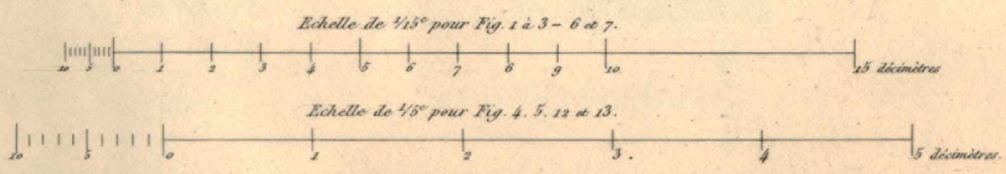
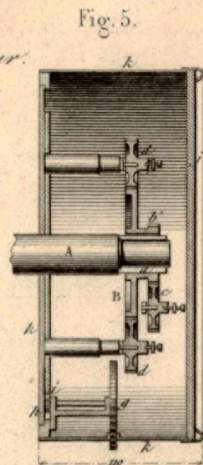



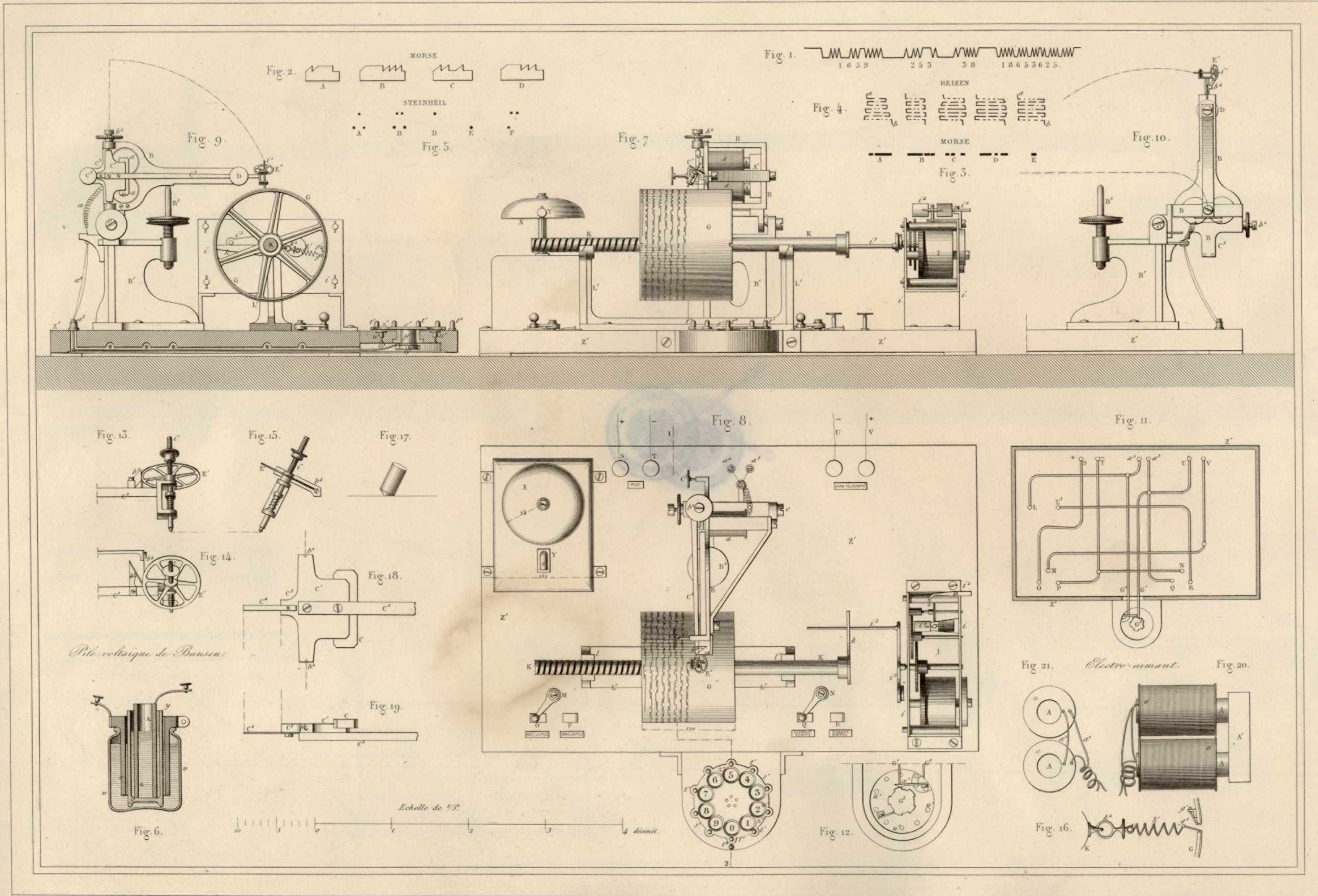

J. Petitcolin sculp.

Armengaud aîné.

Pont suspendu sur la Meuse à Seraing, construit par M. Brialmont.

Fig. 1.

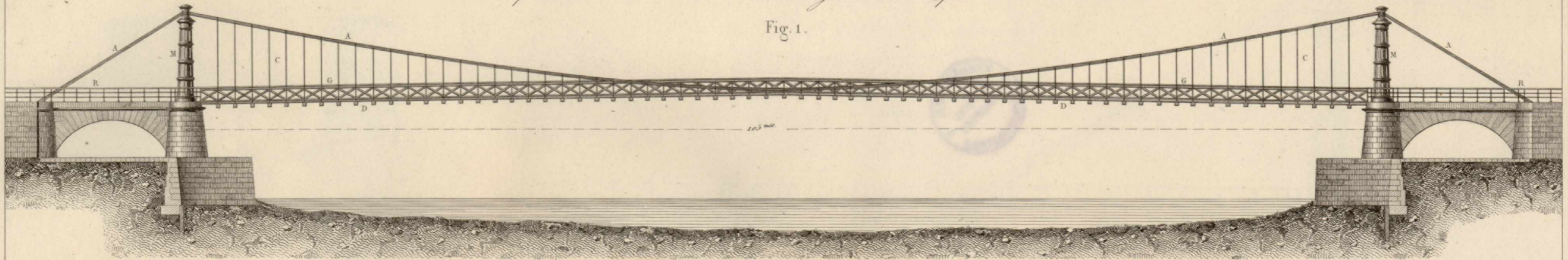
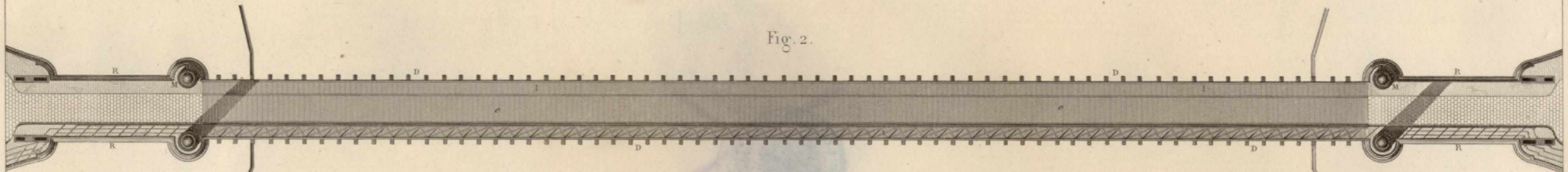

Fig. 2.



Nouveau système de Pont par M. M. Cadiat et Aubry.

Fig. 22.

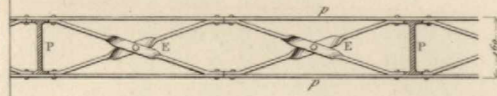

Fig. 23.

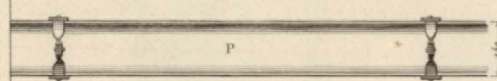

Fig. 21.

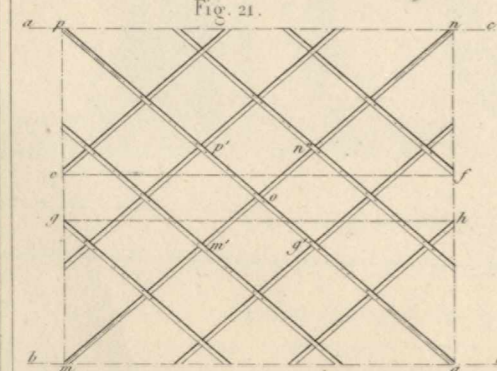

Fig. 24.

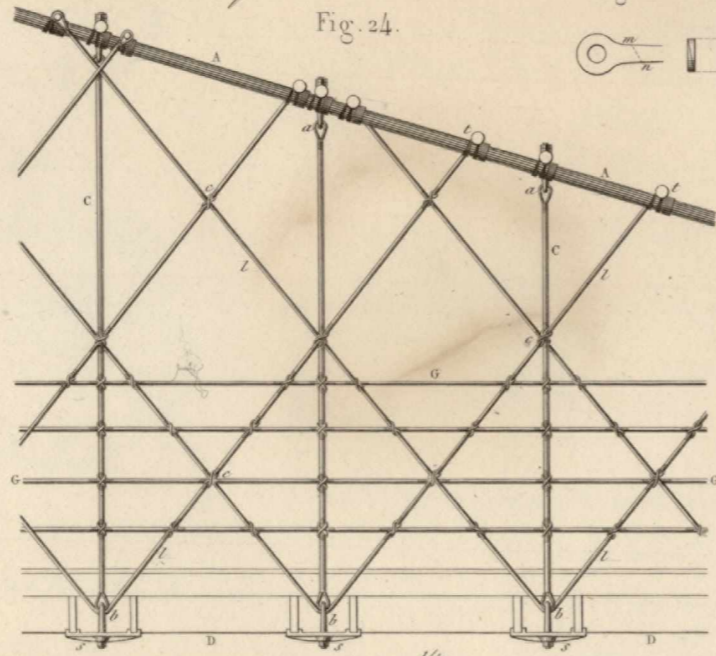

Fig. 13.



Fig. 14.

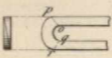

Fig. 15.

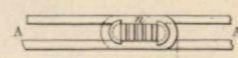

Fig. 11.

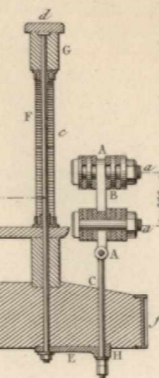

Fig. 10.

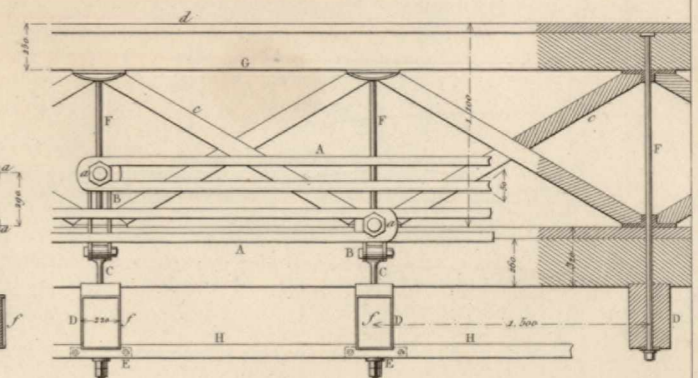

Fig. 16.

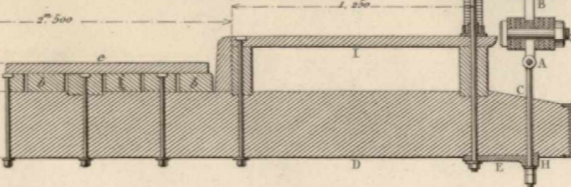
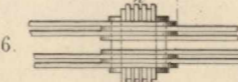

Fig. 25.



Fig. 12.



Fig. 26.

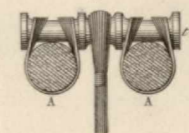

Fig. 27.

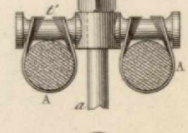
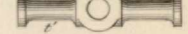
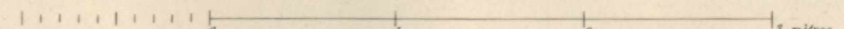

Fig. 28.



Echelle de 1/40 pour Fig. 11 à 15 et 24.



Expériences de M. M. Cadriat et Oudry.

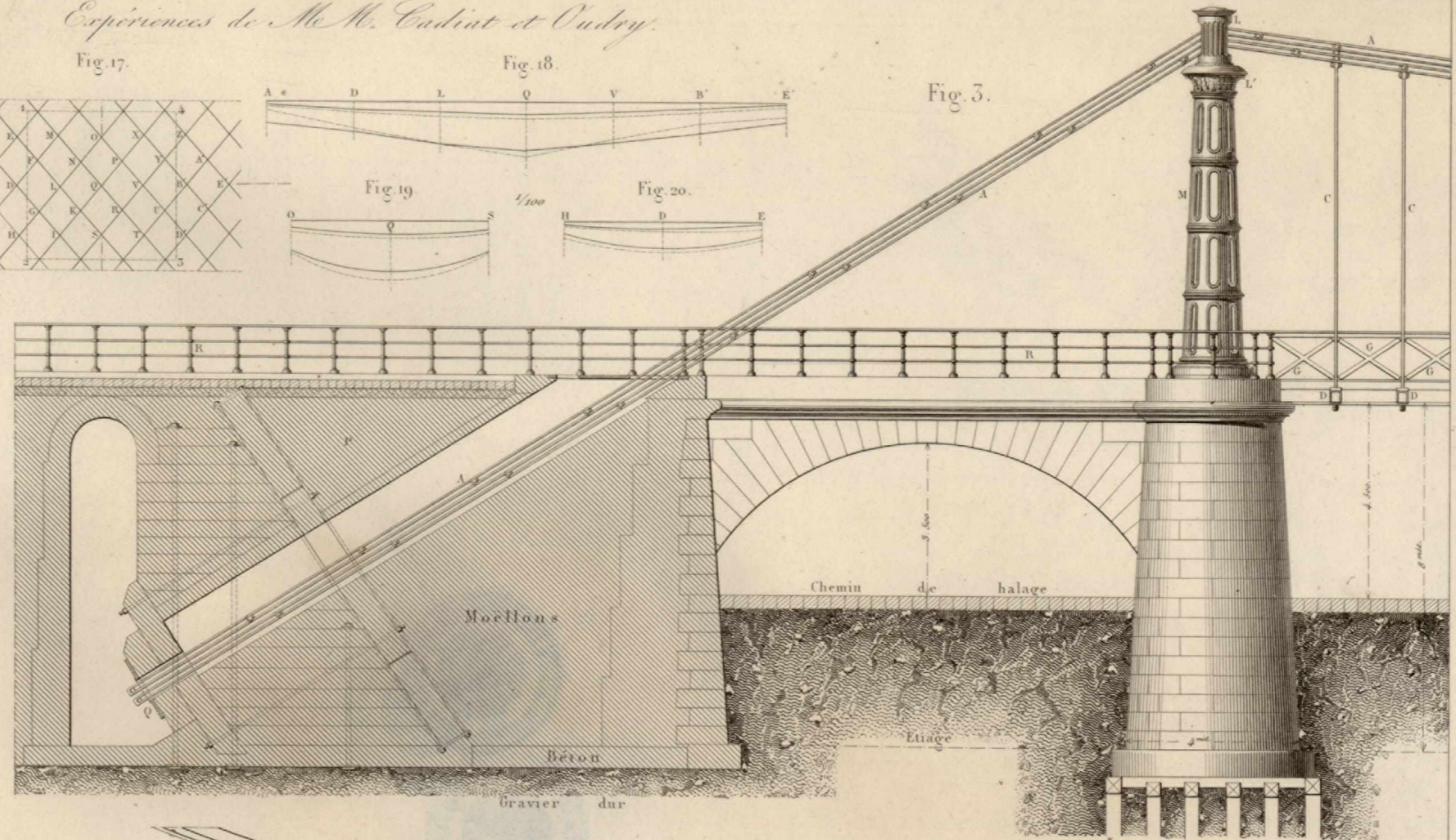
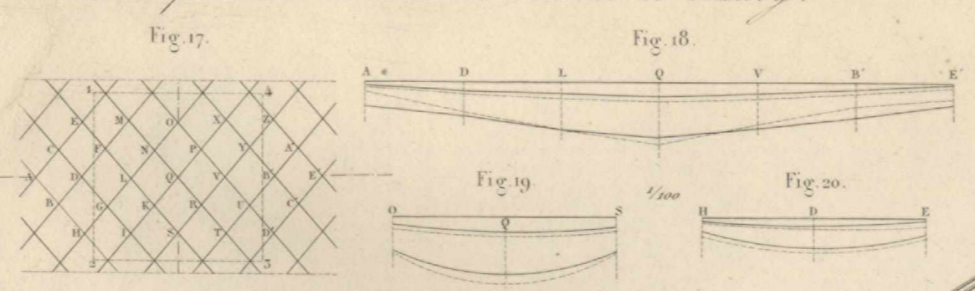
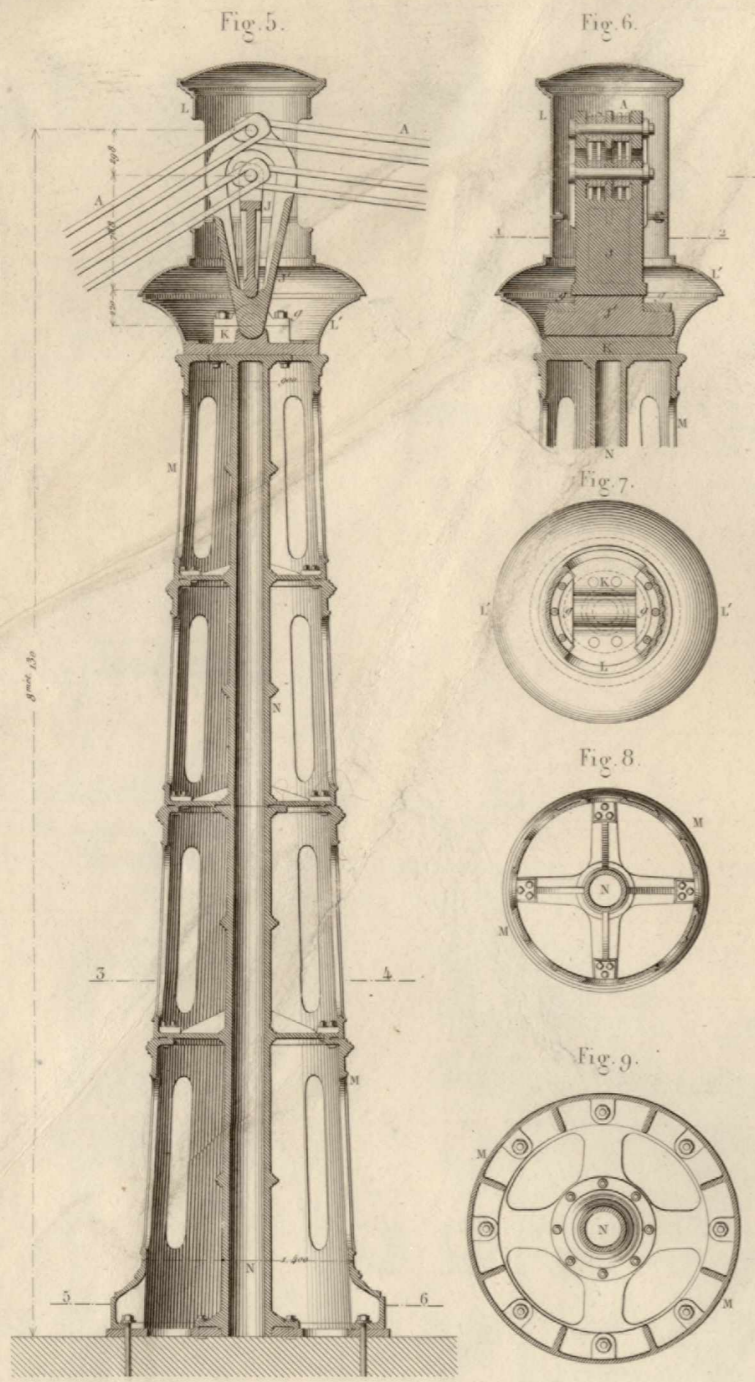

Pont suspendu sur la Meuse à Servain.

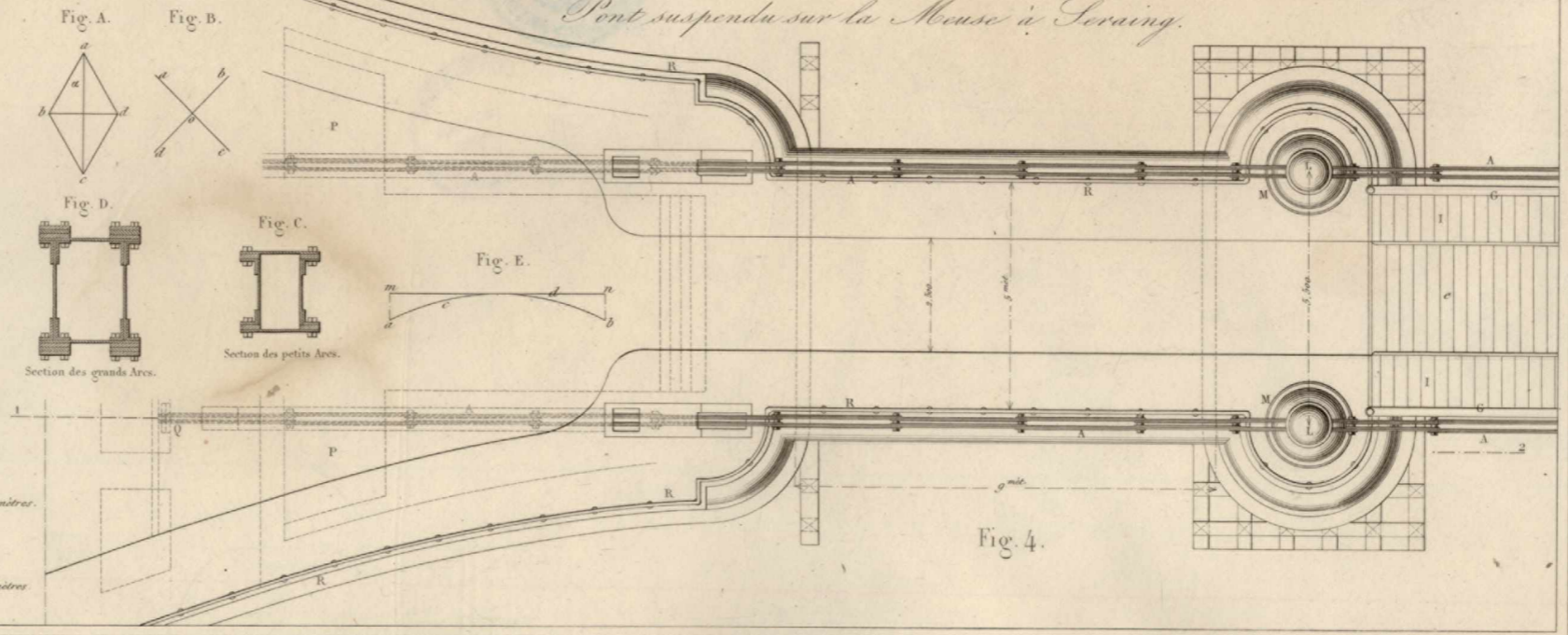

Echelle de 1/100 pour Fig. 3 et 4.
 Echelle de 1/30 pour Fig. 5 à 9.

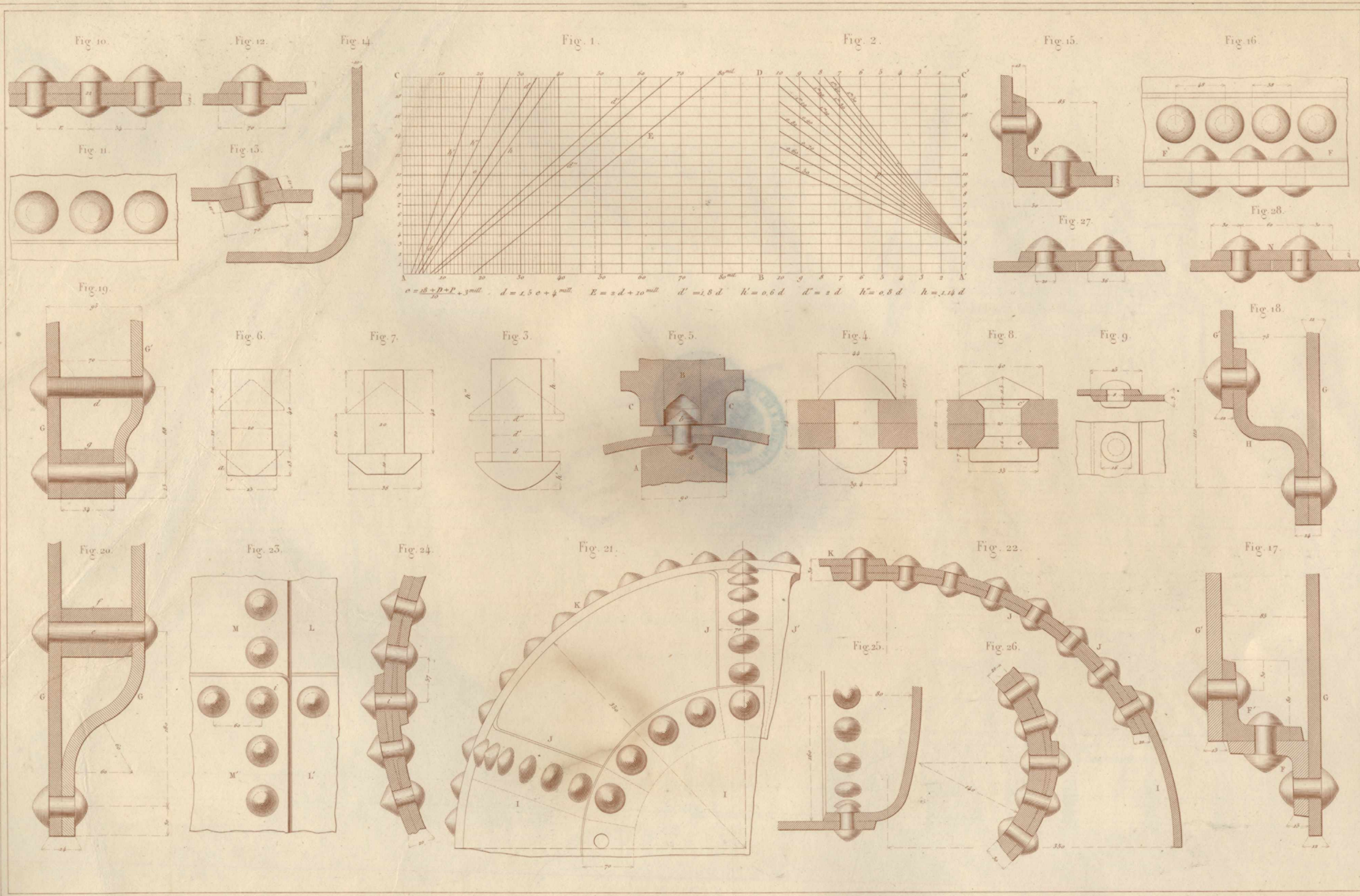

$c = \frac{2B + D + P}{10} + 3 \text{ mill.}$ $d = 2.5c + 4 \text{ mill.}$ $E = 2d + 20 \text{ mill.}$ $d' = 1.8d$ $h = 0.6d$ $d'' = 2d$ $h' = 0.8d$ $h'' = 1.14d$

Voile à planches mobiles, par M. Berton.

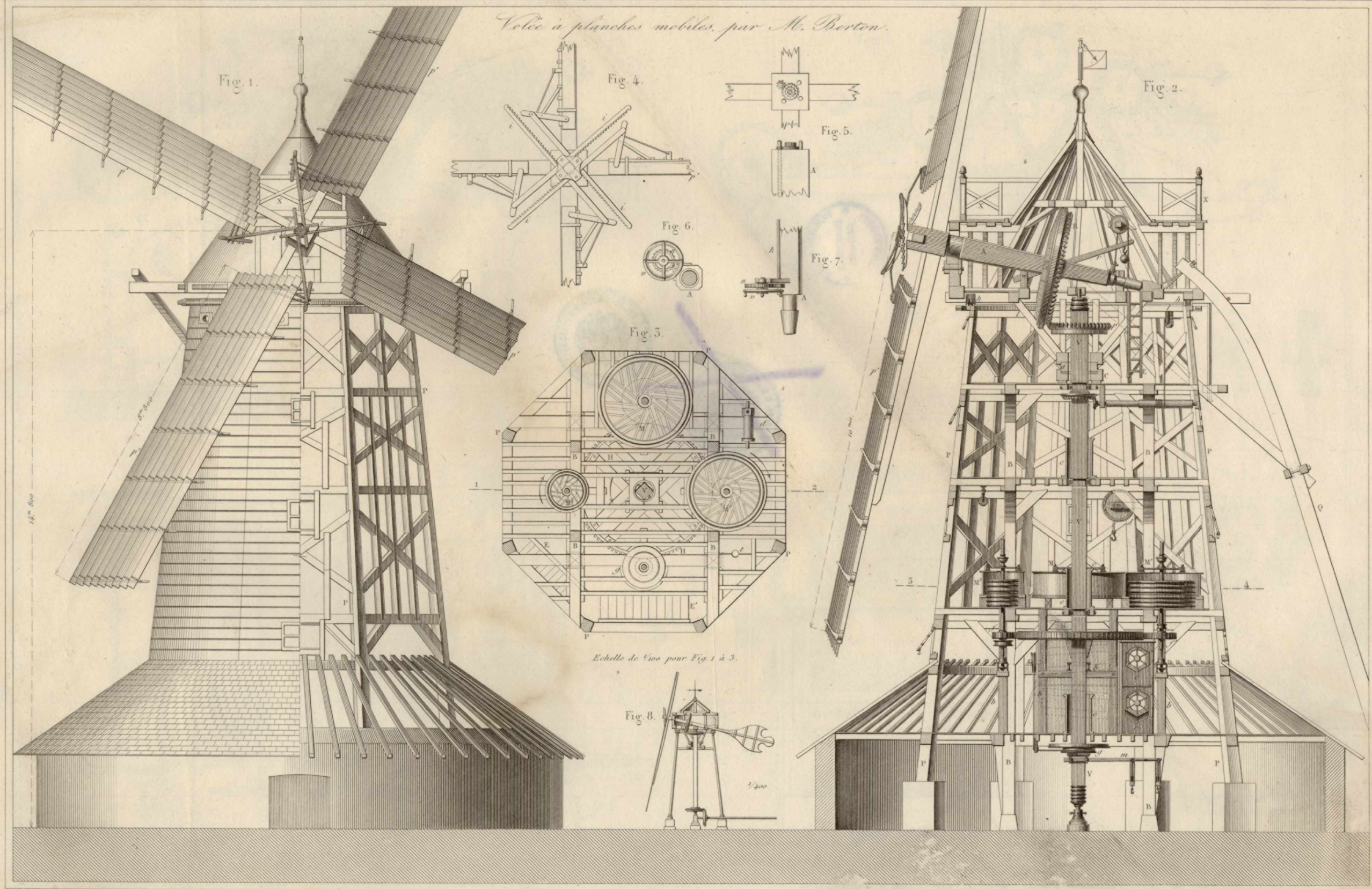

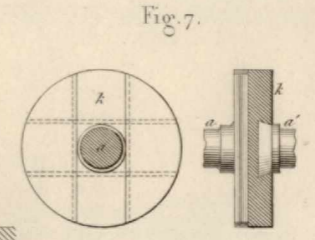
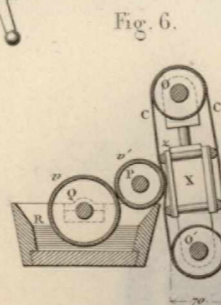
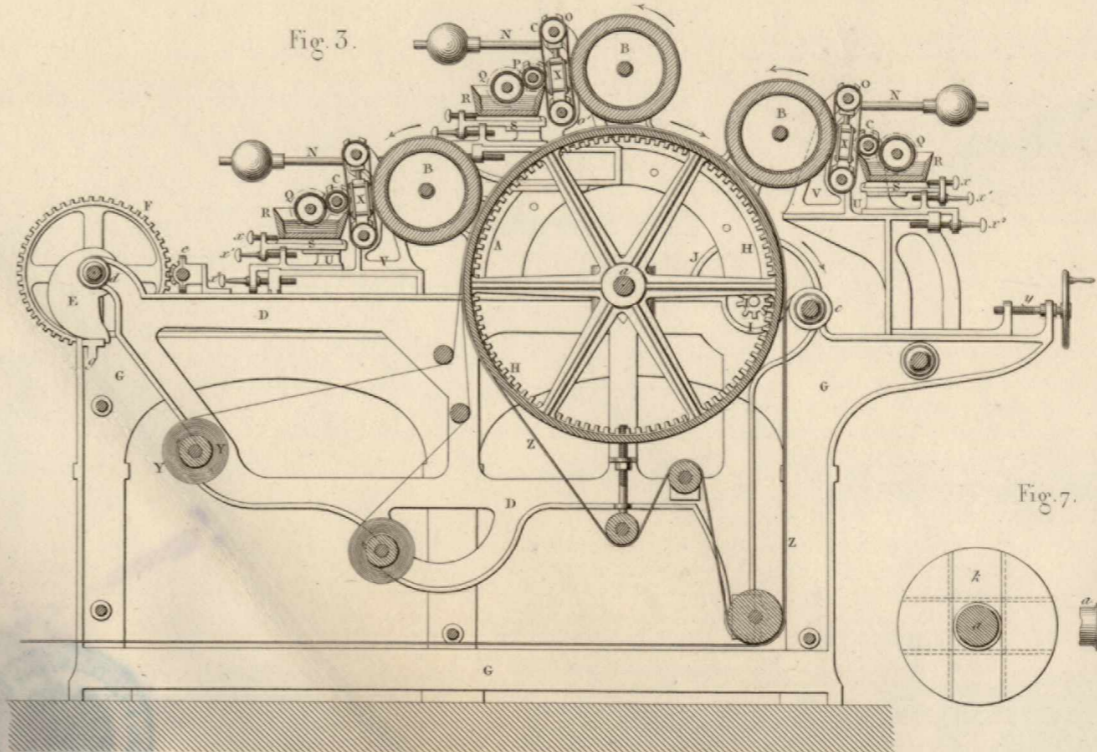
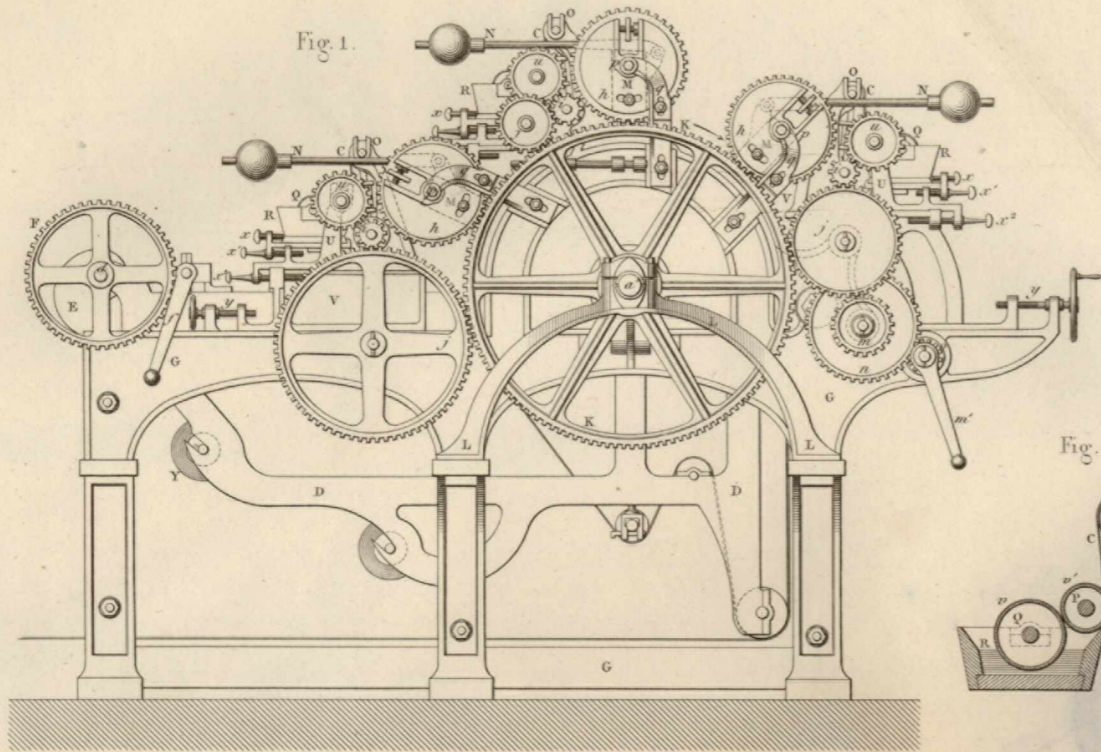

Fig. 2.

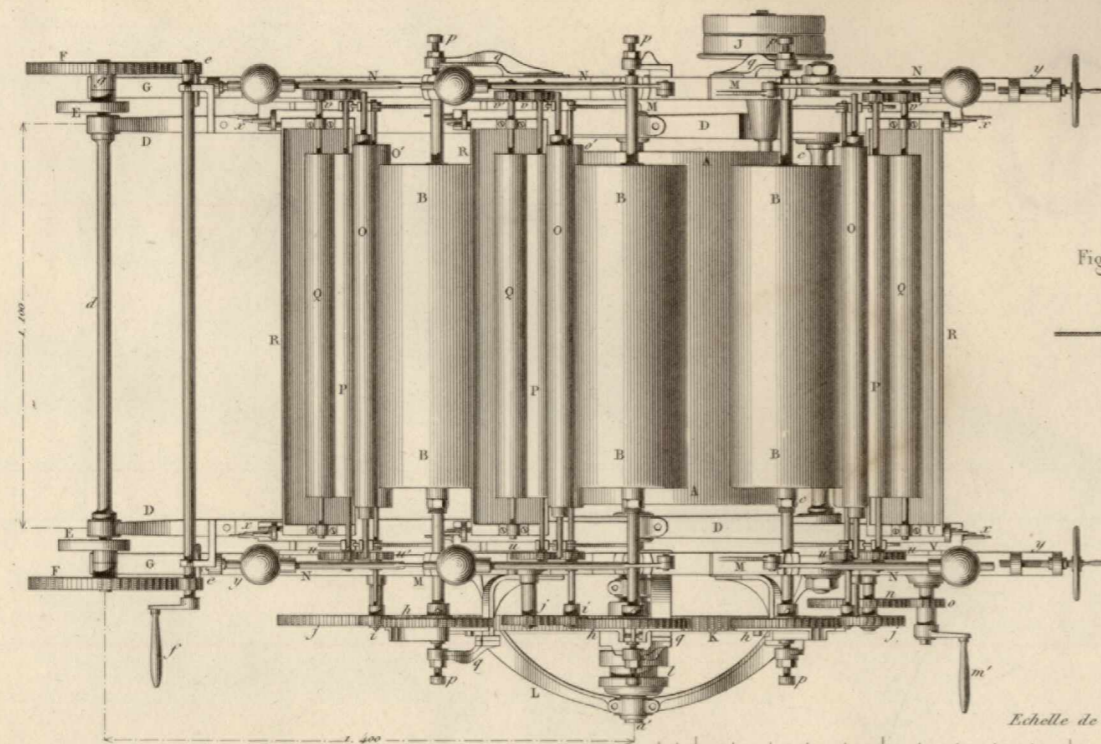
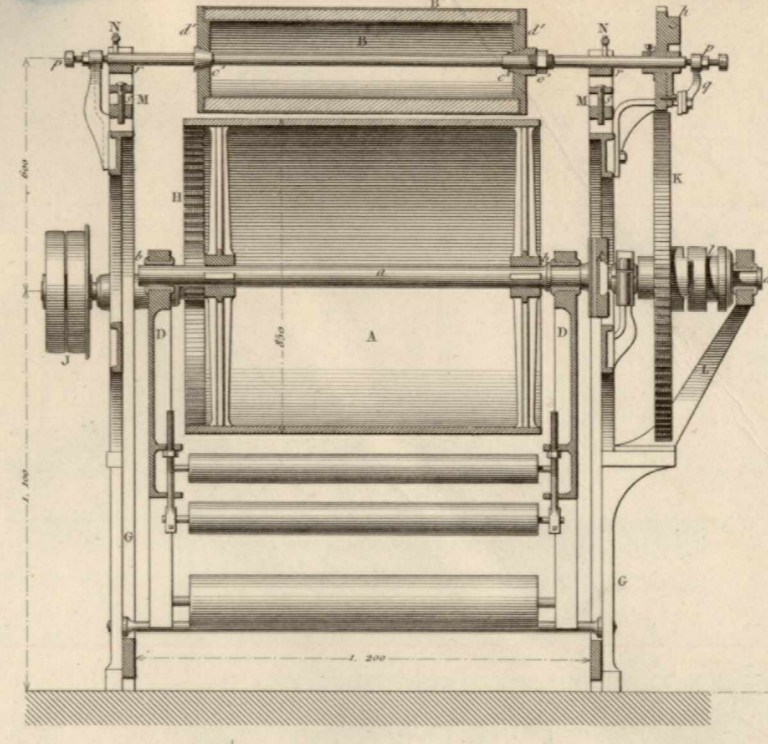

Fig. 5.

Echelle de 1/20^e.

Fig. 4.



20 centimètres.

Fig. 8.

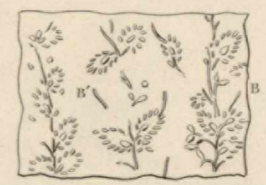

Fig. 9.

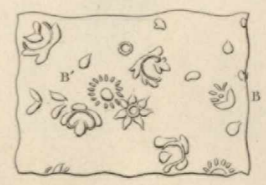
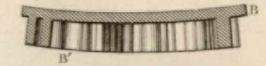
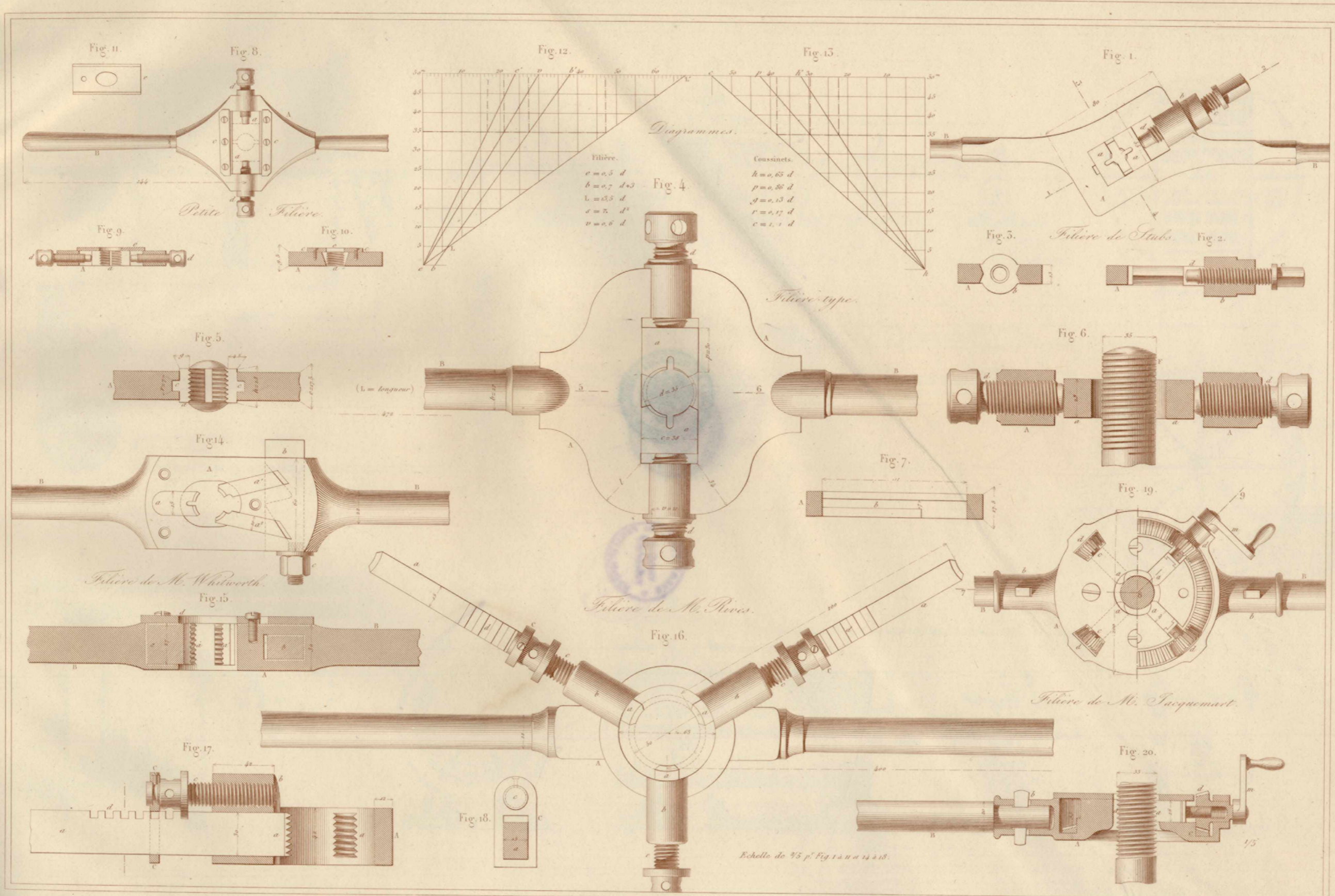

Fig. 10.





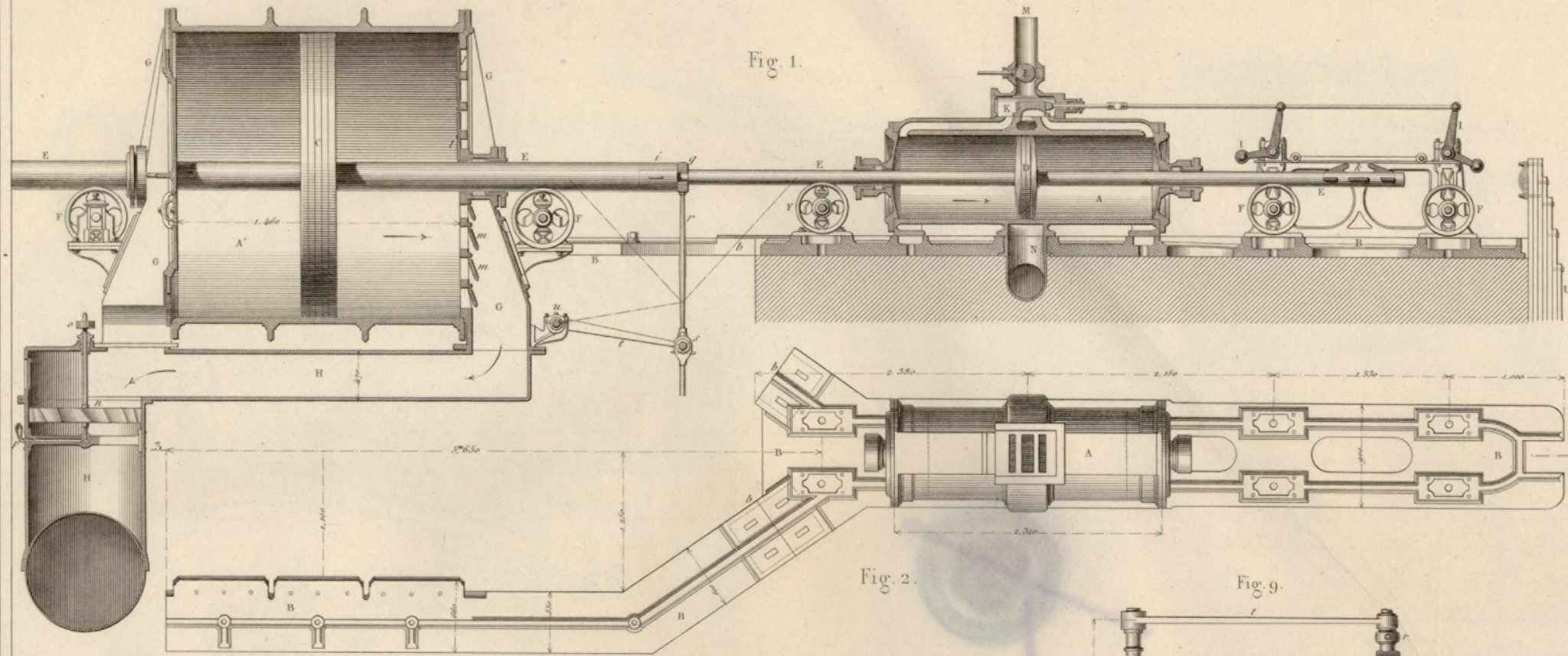

Fig. 1.

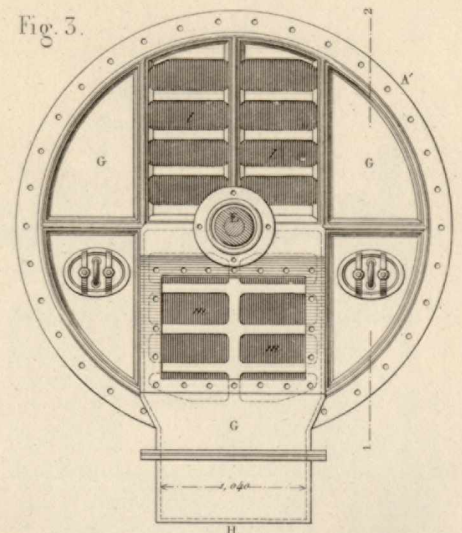

Fig. 3.

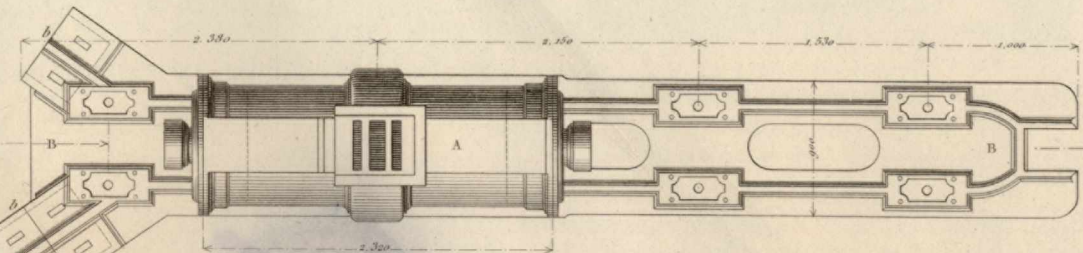

Fig. 2.

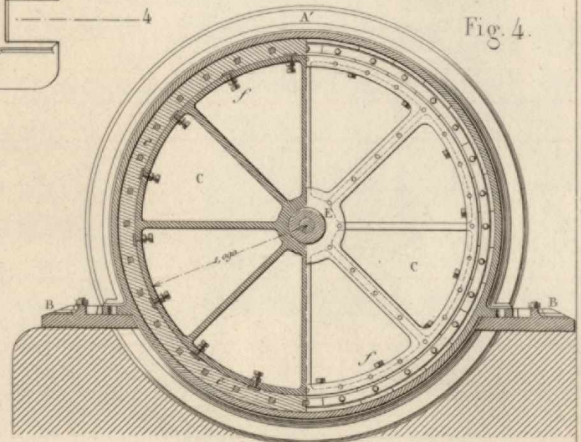

Fig. 4.

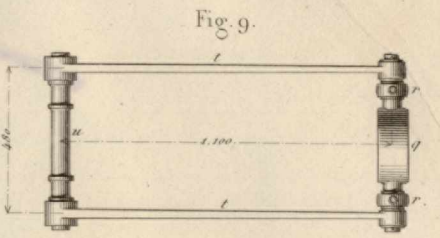

Fig. 9.

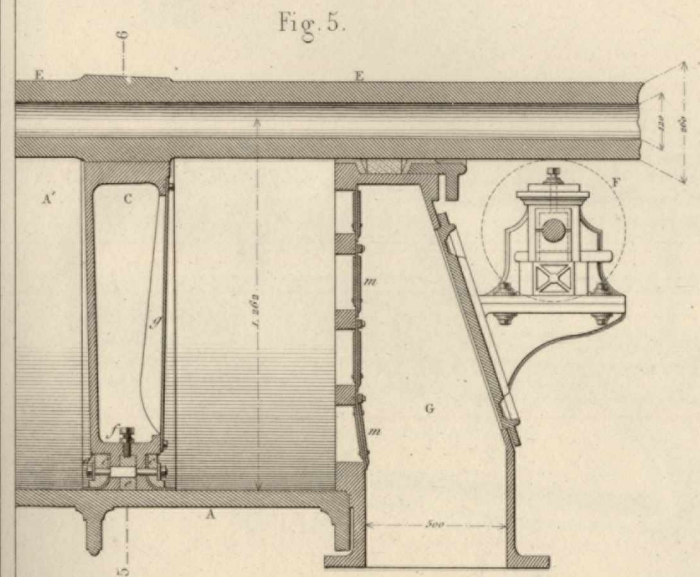

Fig. 5.

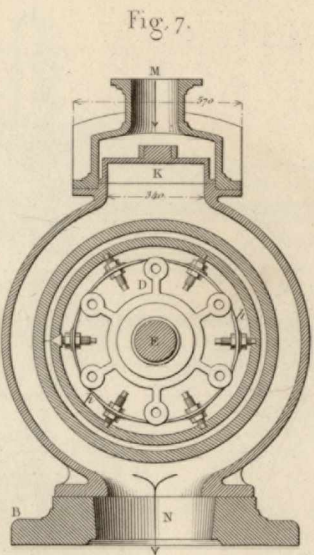

Fig. 7.

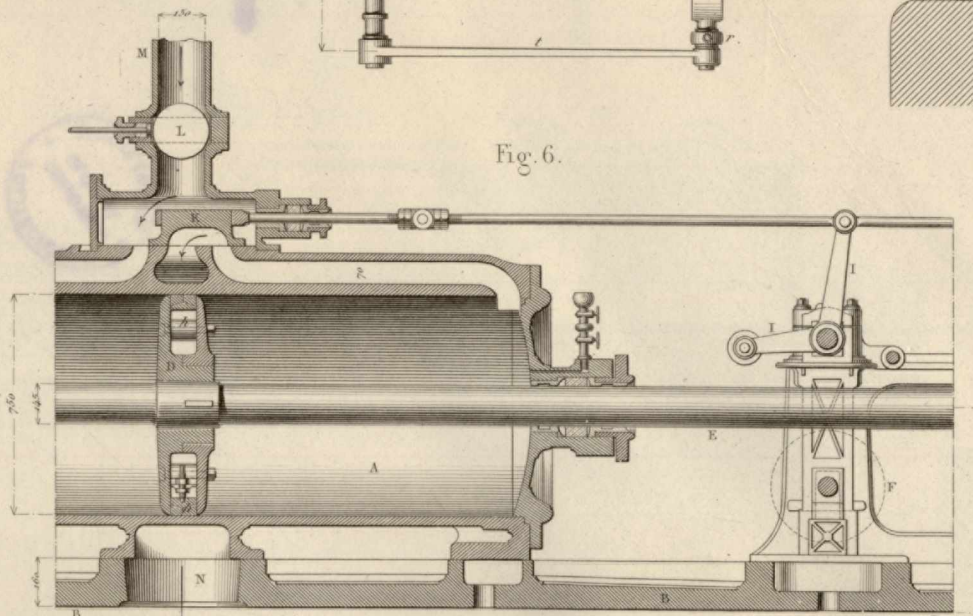

Fig. 6.

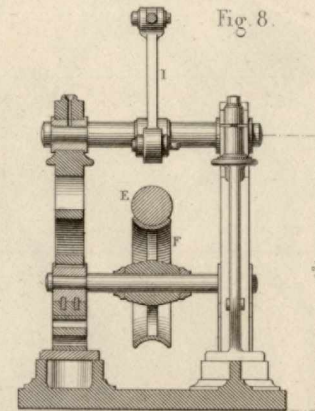
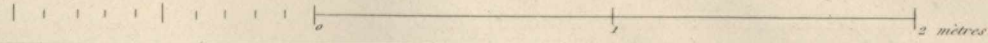
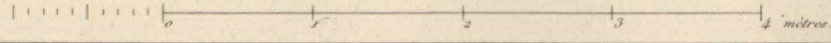
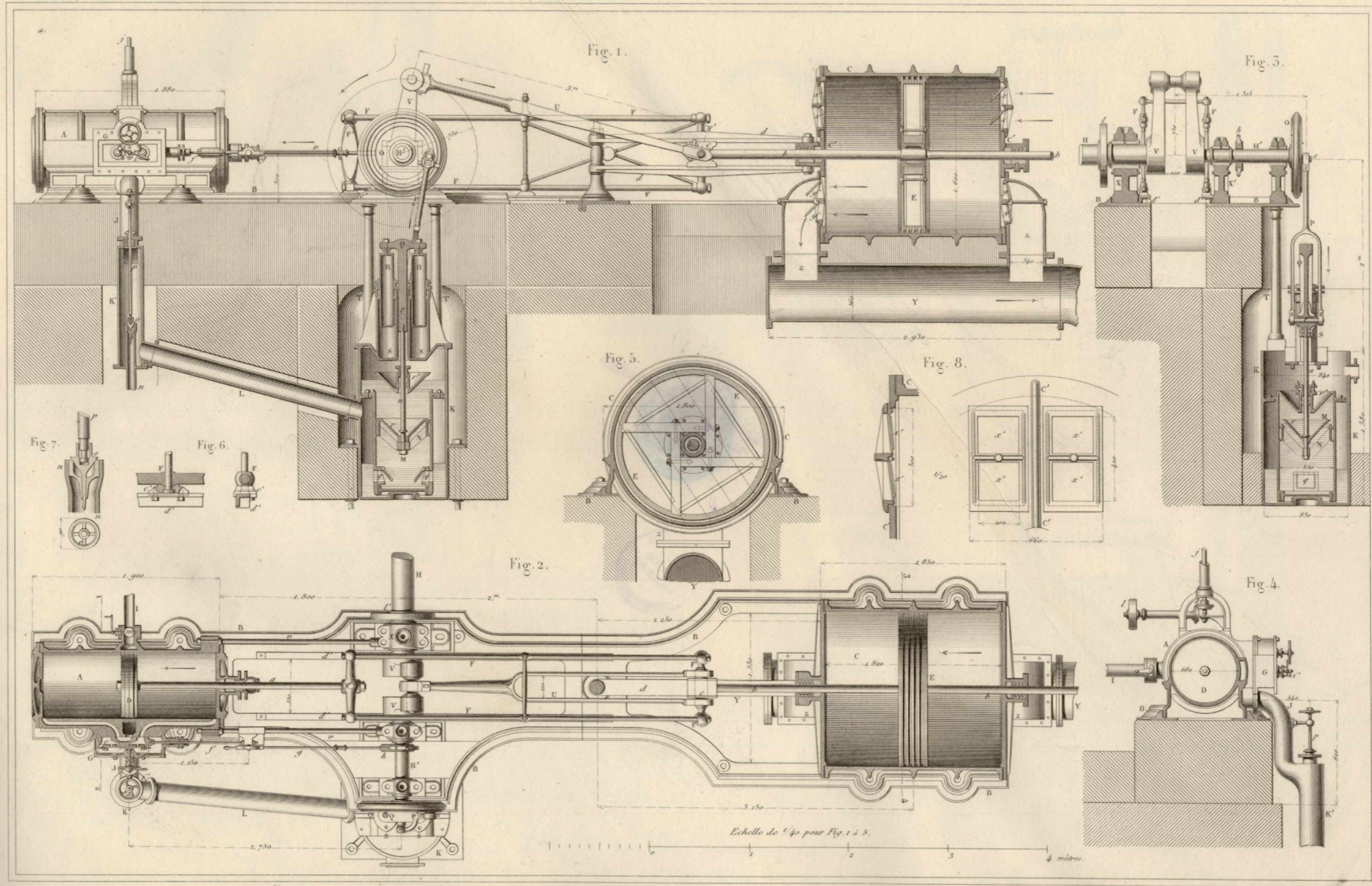

Fig. 8.

Echelle de 1/50 pour Fig. 1 à 4

Echelle de 1/25 pour Fig. 5 à 9.





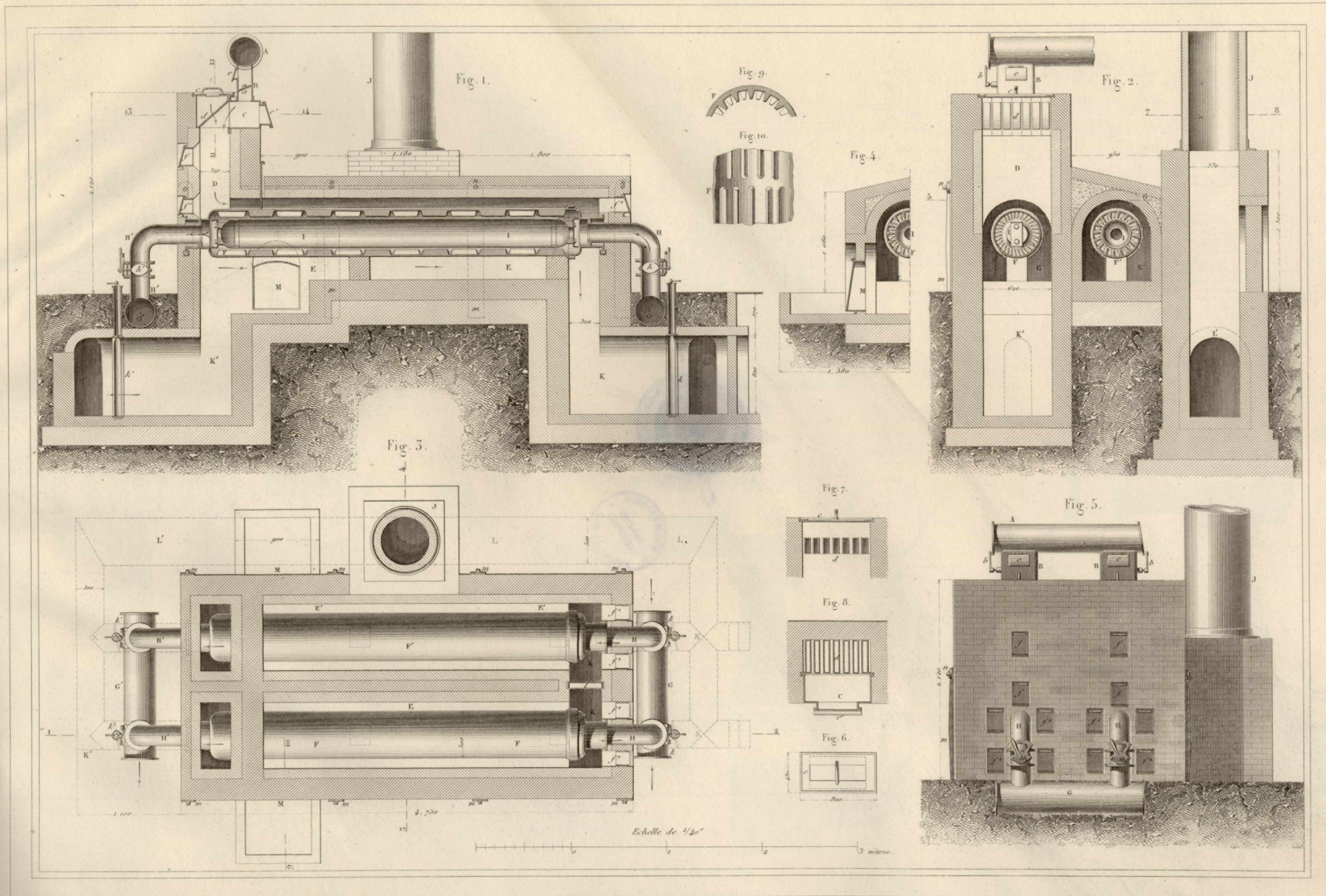

J. Petitcolin sculp.

Armengaud ainc.

Fig. 2.
Manivelles en fer.

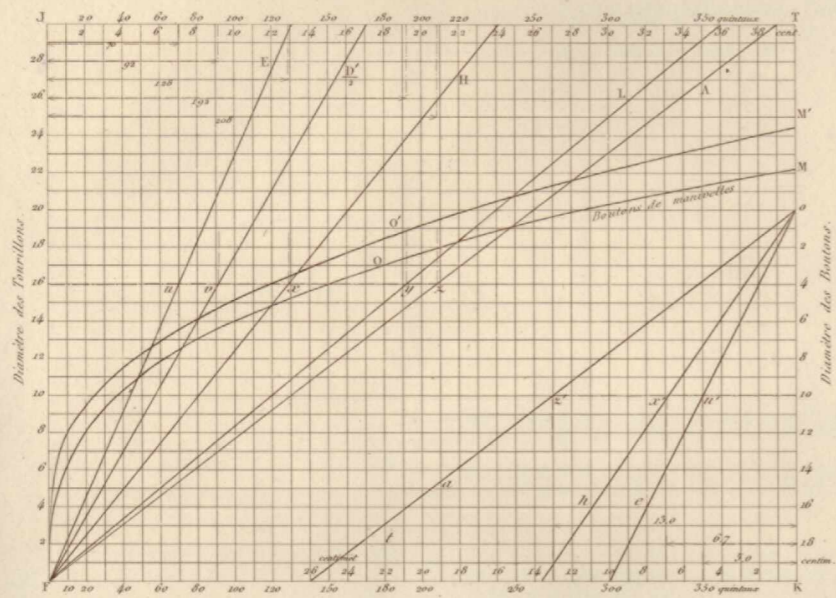

Fig. 1.
Courbilles d'arbres premiers moteurs (1/2)

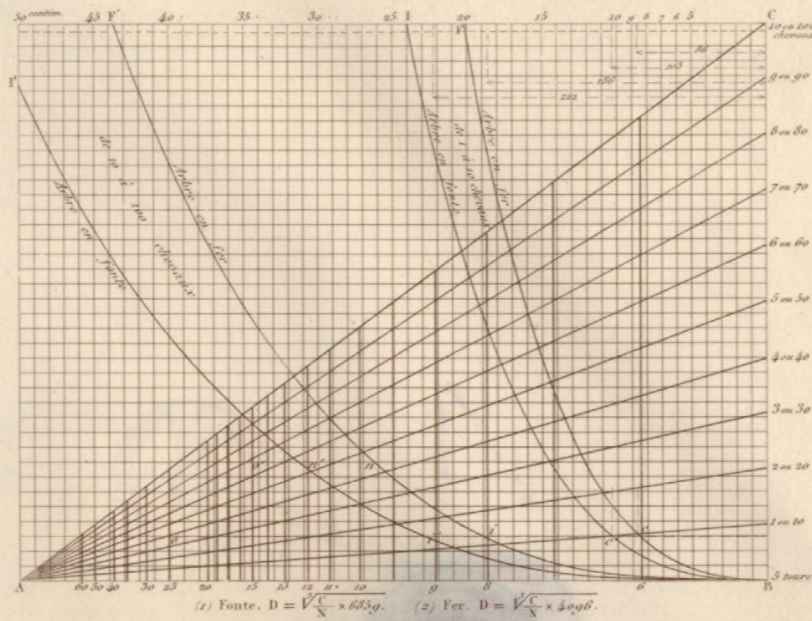

Fig. 3.
Manivelles en fonte.

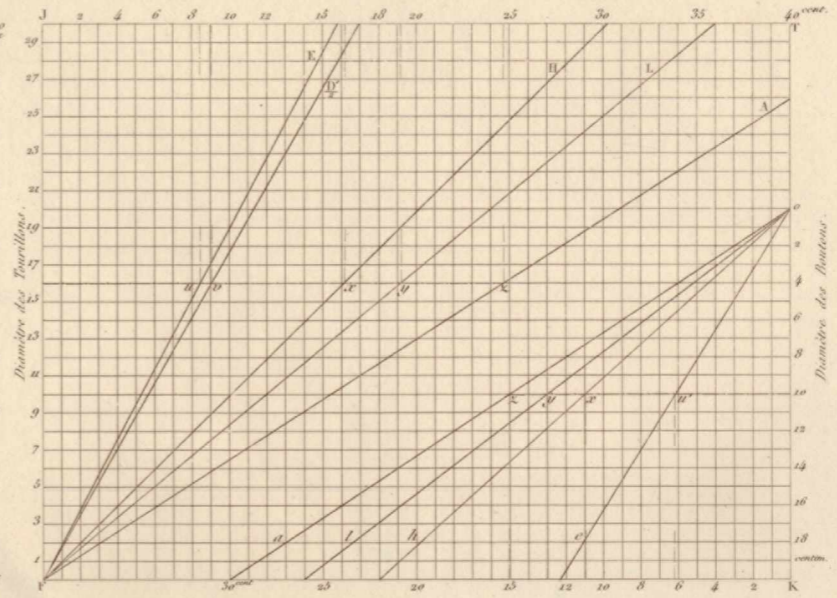

Fig. 5.

Fig. 4.

Fig. 12.

Fig. 7.

Fig. 8.

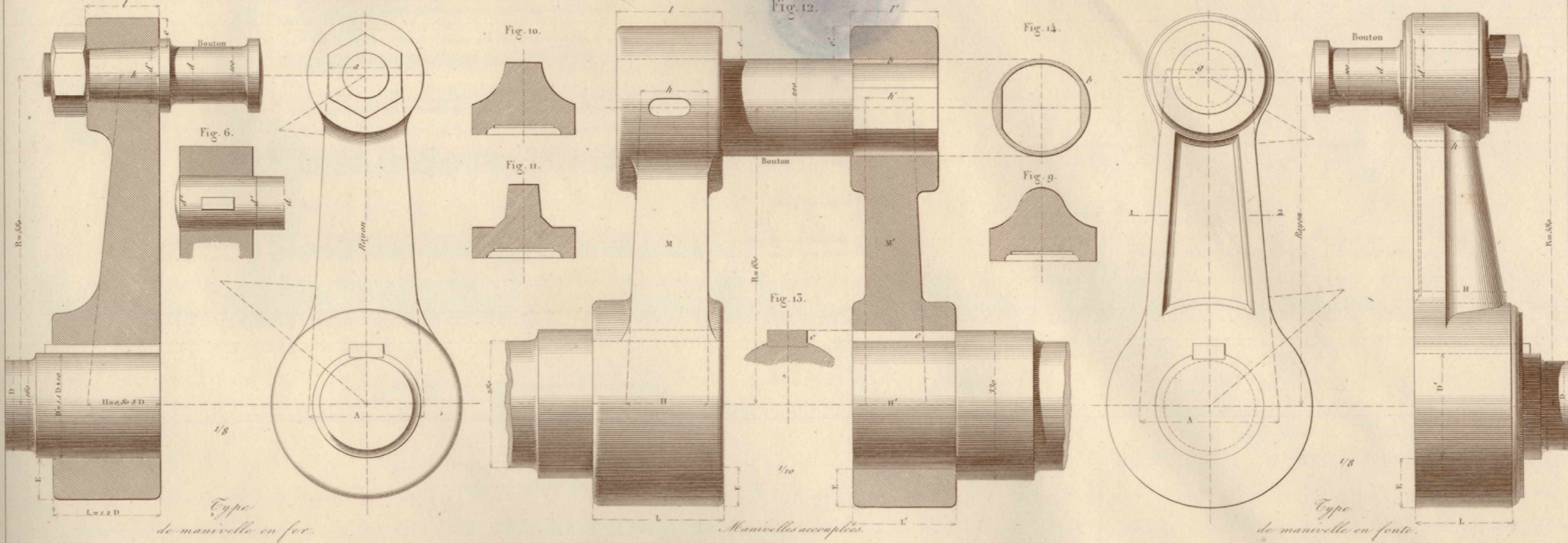

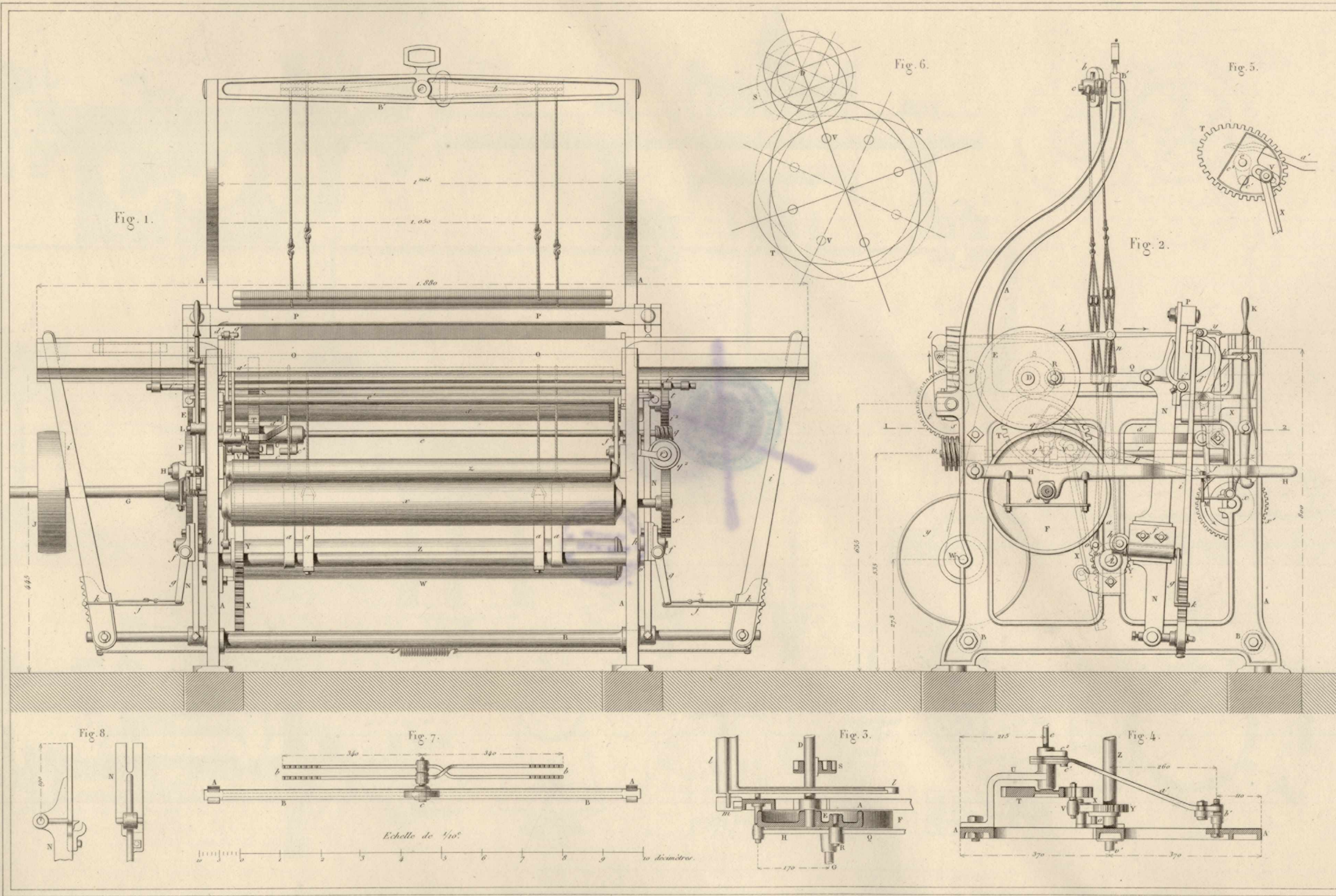

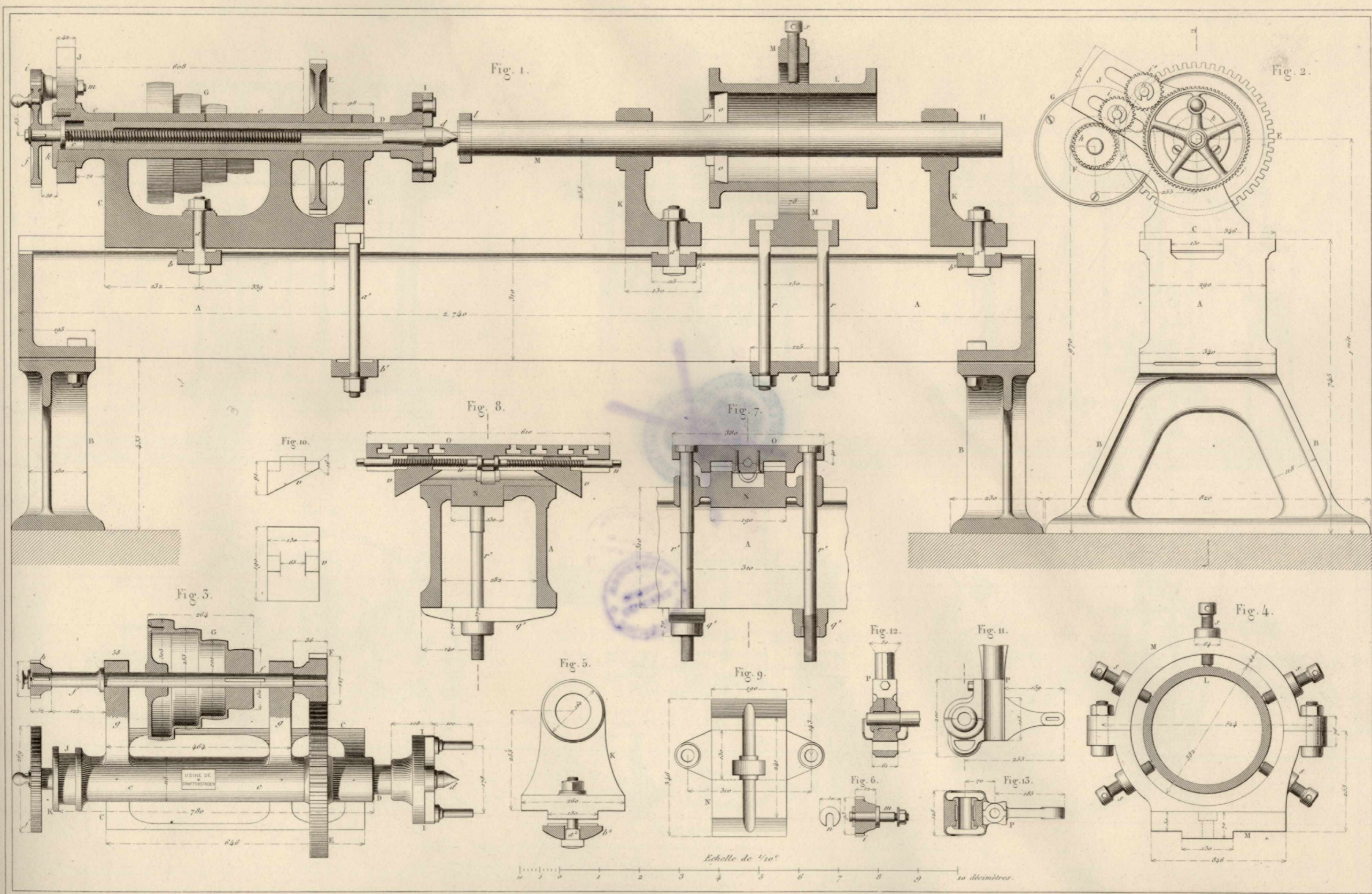

Fig. 1.

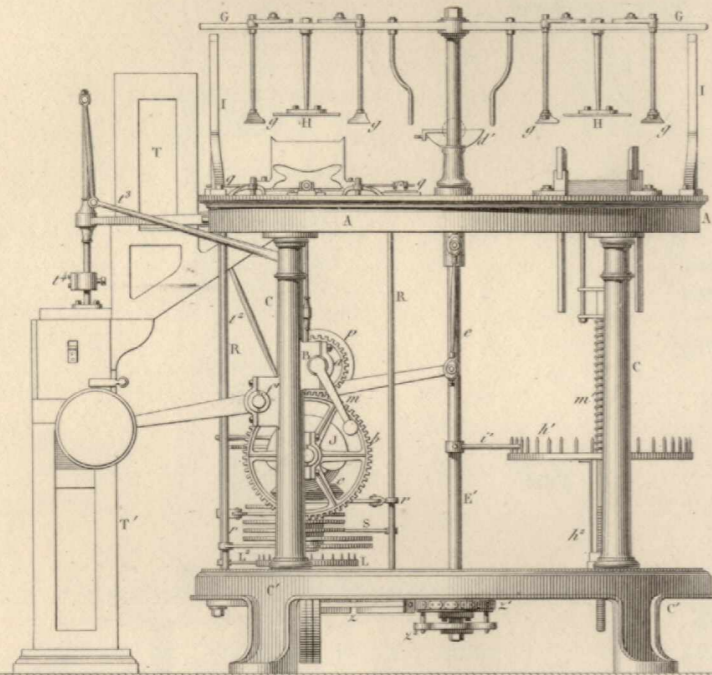

Fig. 3.

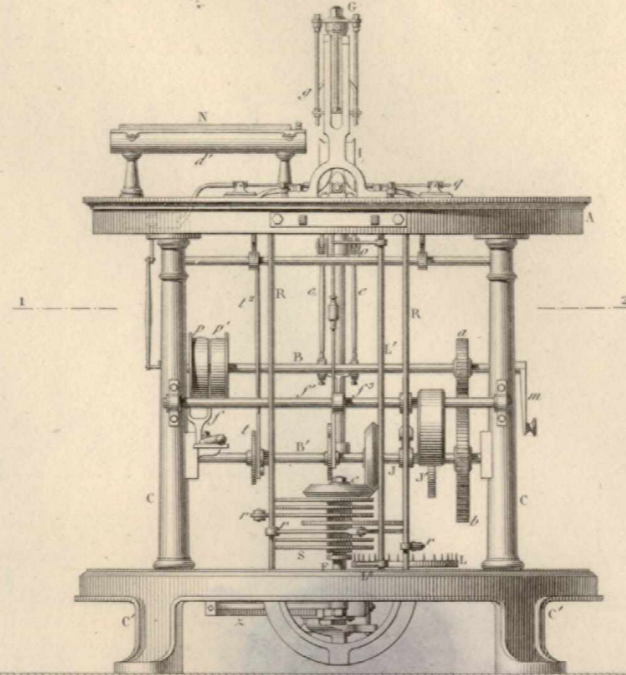

Fig. 4.

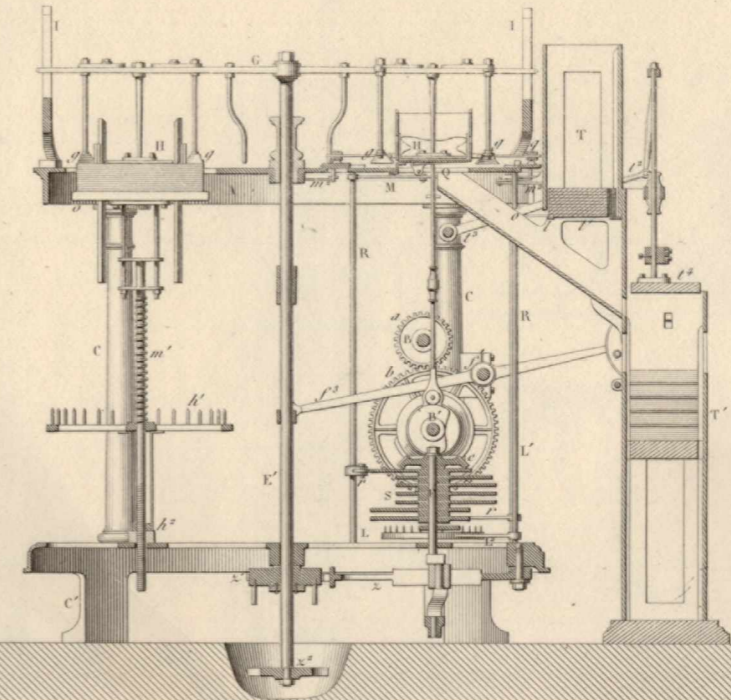

Fig. 2.

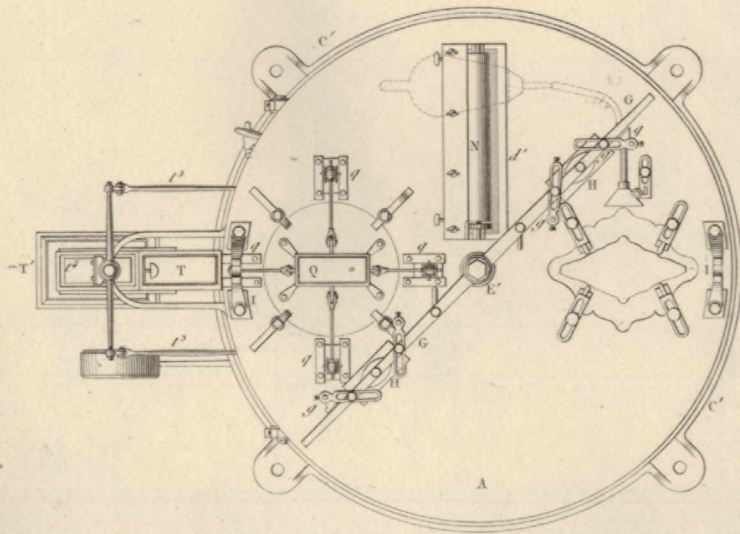

Fig. 6.

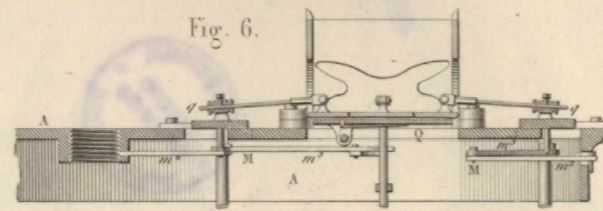

Fig. 7.

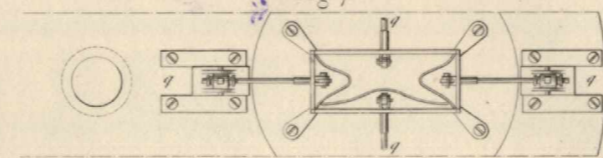

Fig. 9.

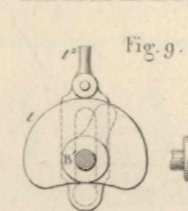
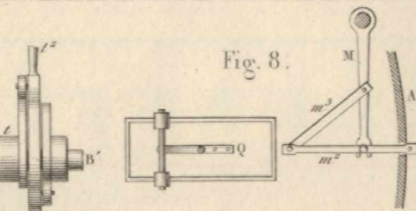

Fig. 8.



Echelle de 1/45^e pour Fig. 1 à 5.

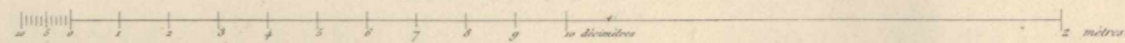
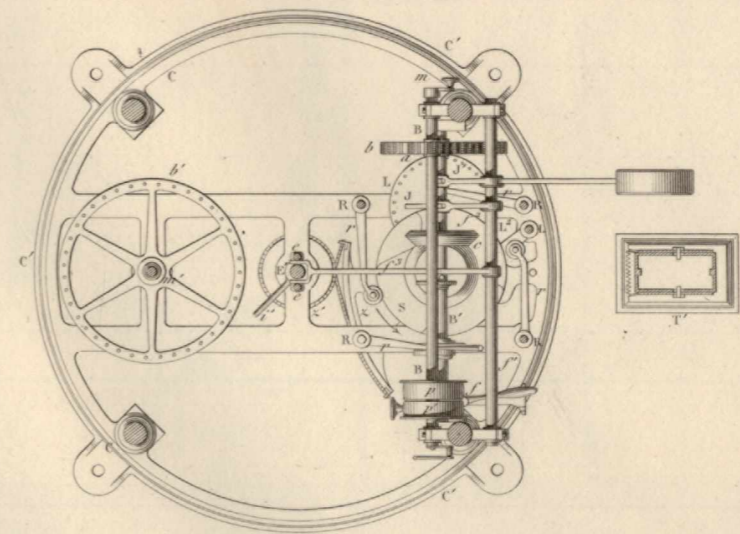
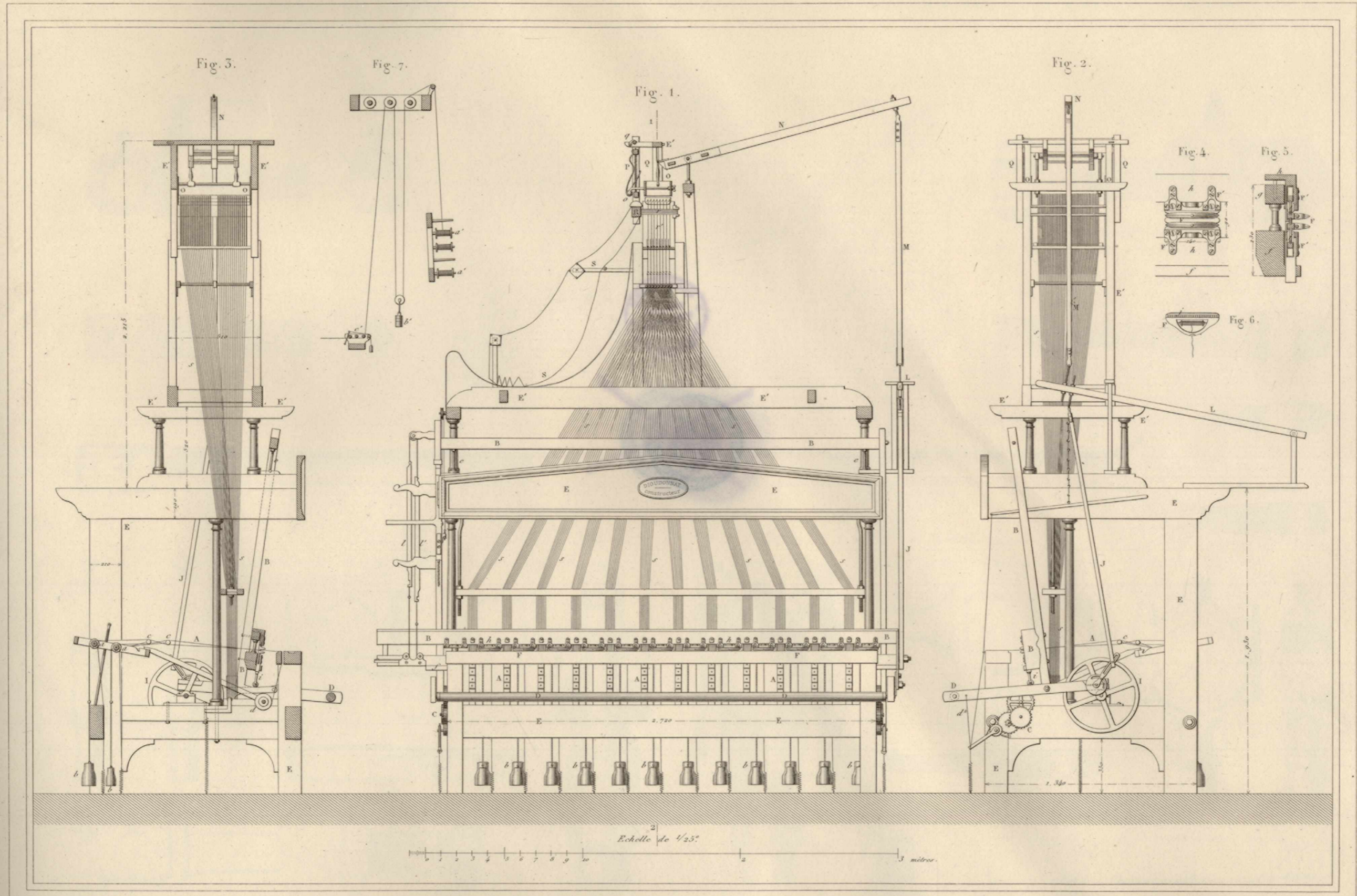

Fig. 5.





J. Petitcolin sculp.

Armengaud aîné.

Exp. de P. Chardon aîné, r. Bouteville, No. 10, Paris.

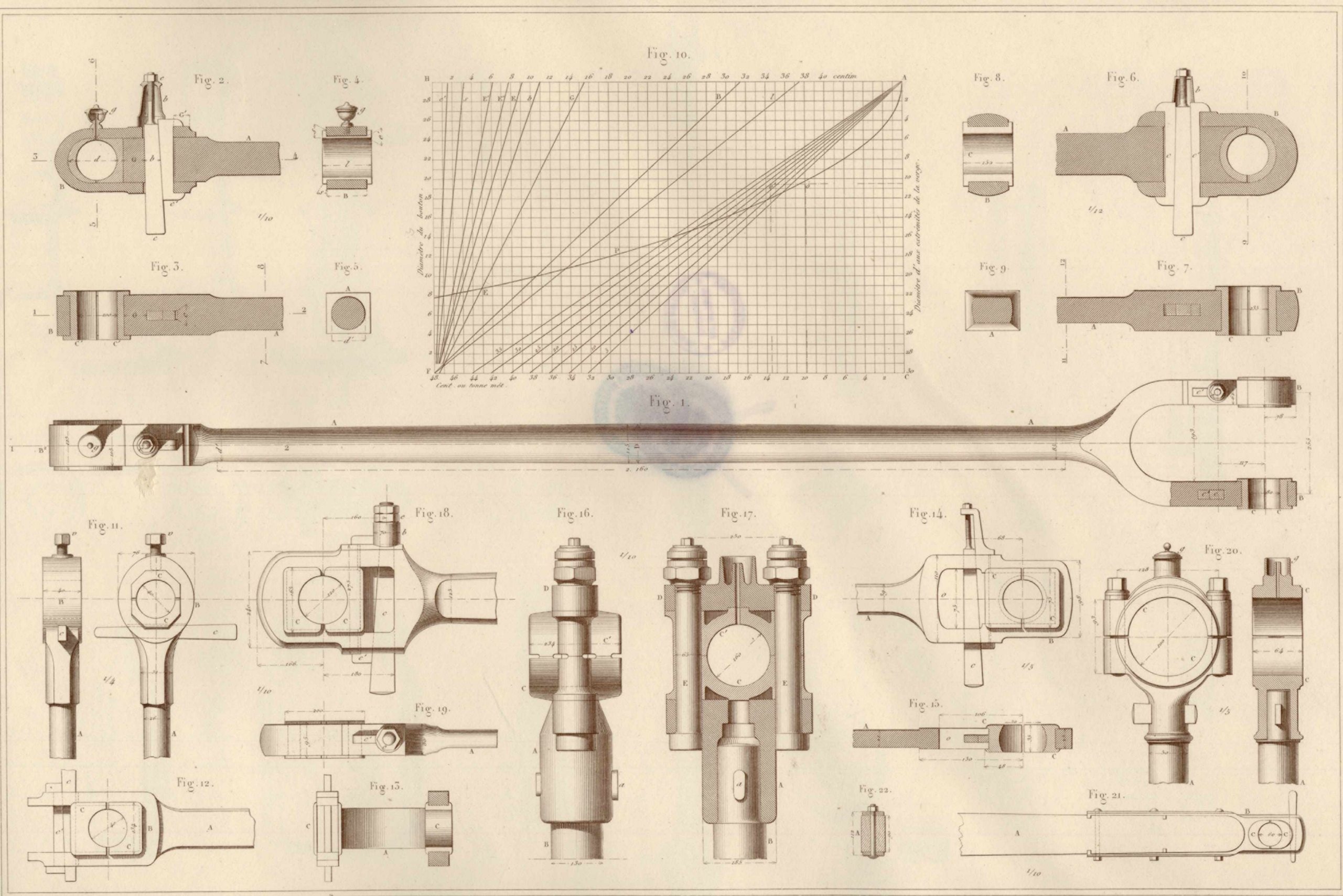

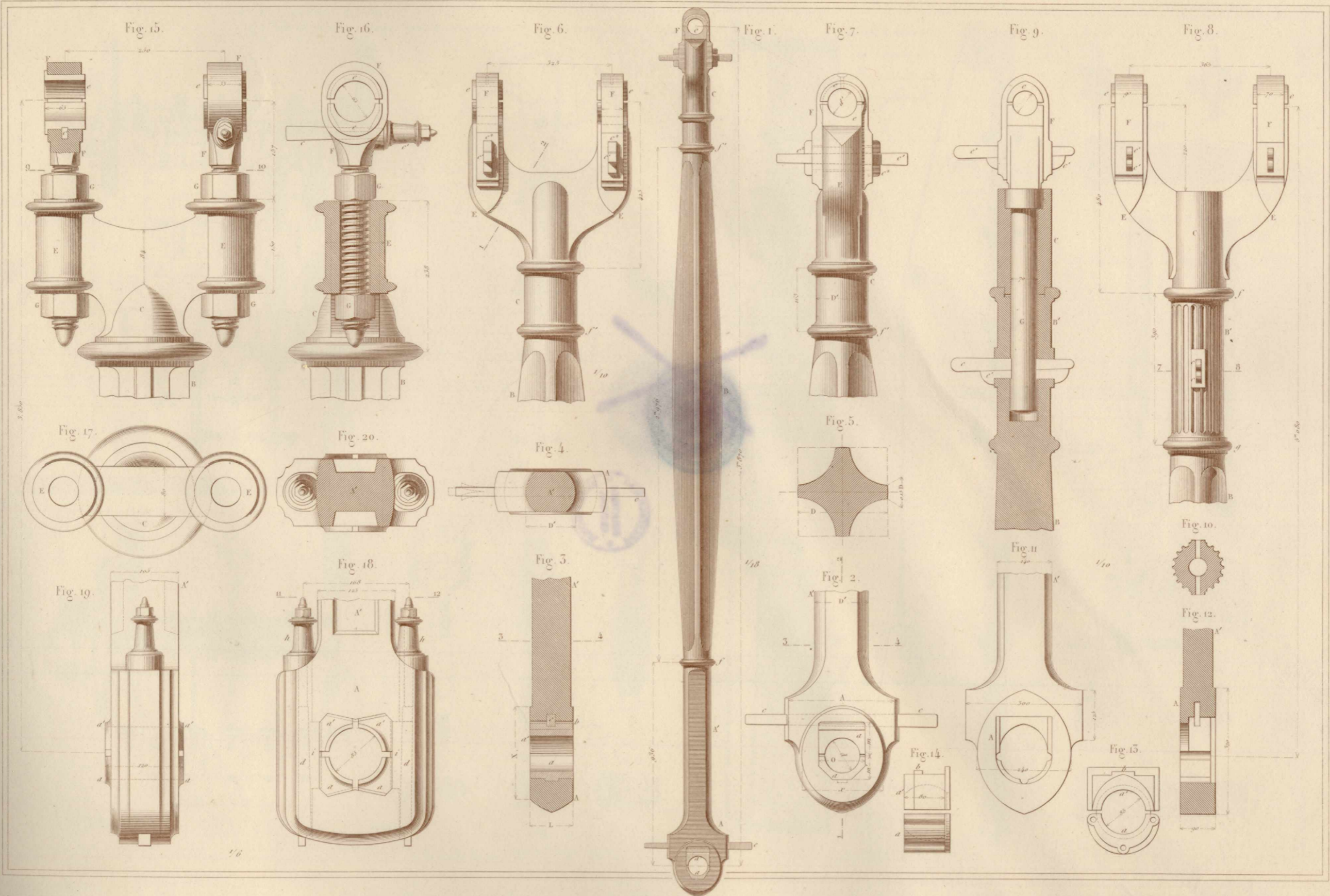

Martinet à plusieurs marteaux et matrices.

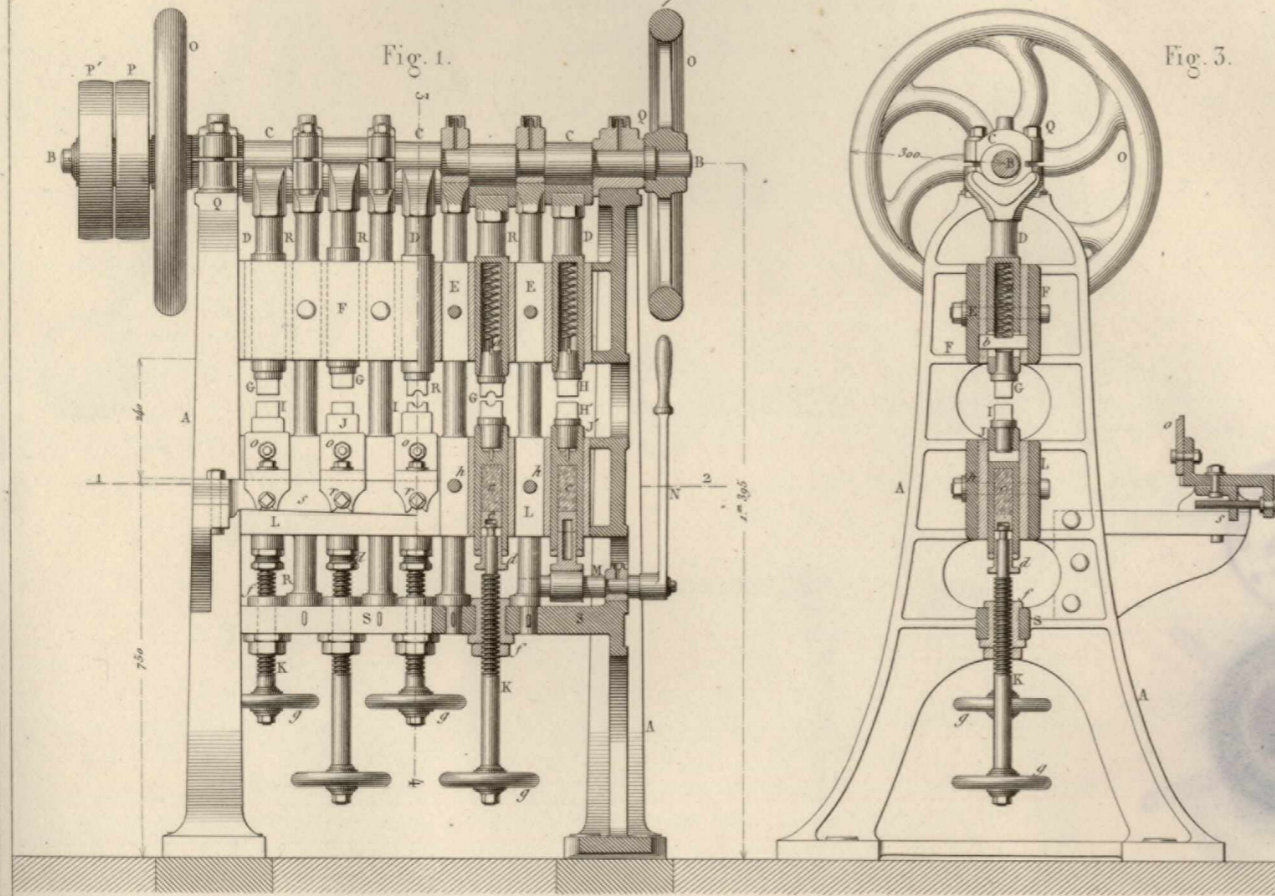

Machine à rainer les canons de fusils.

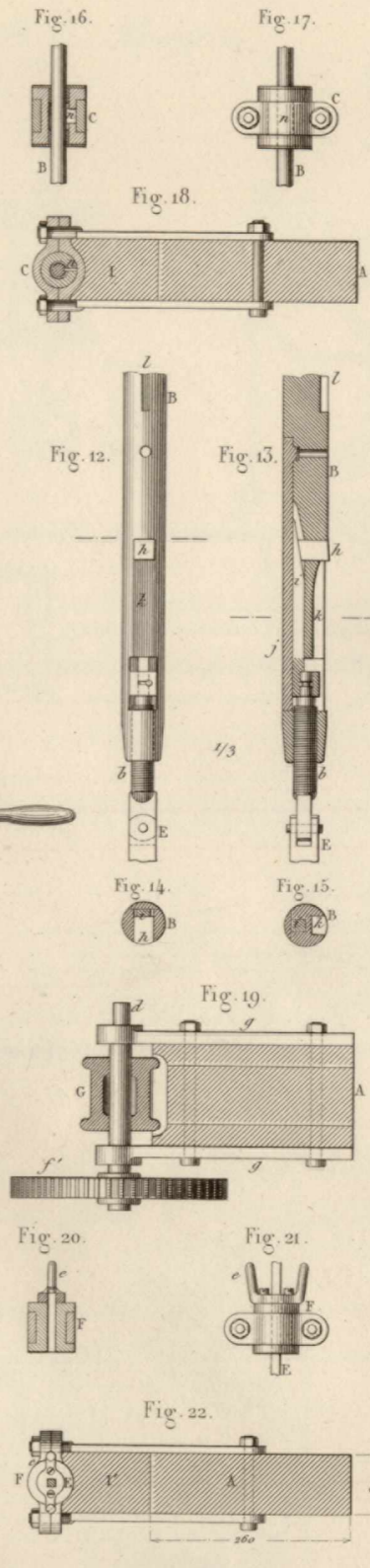
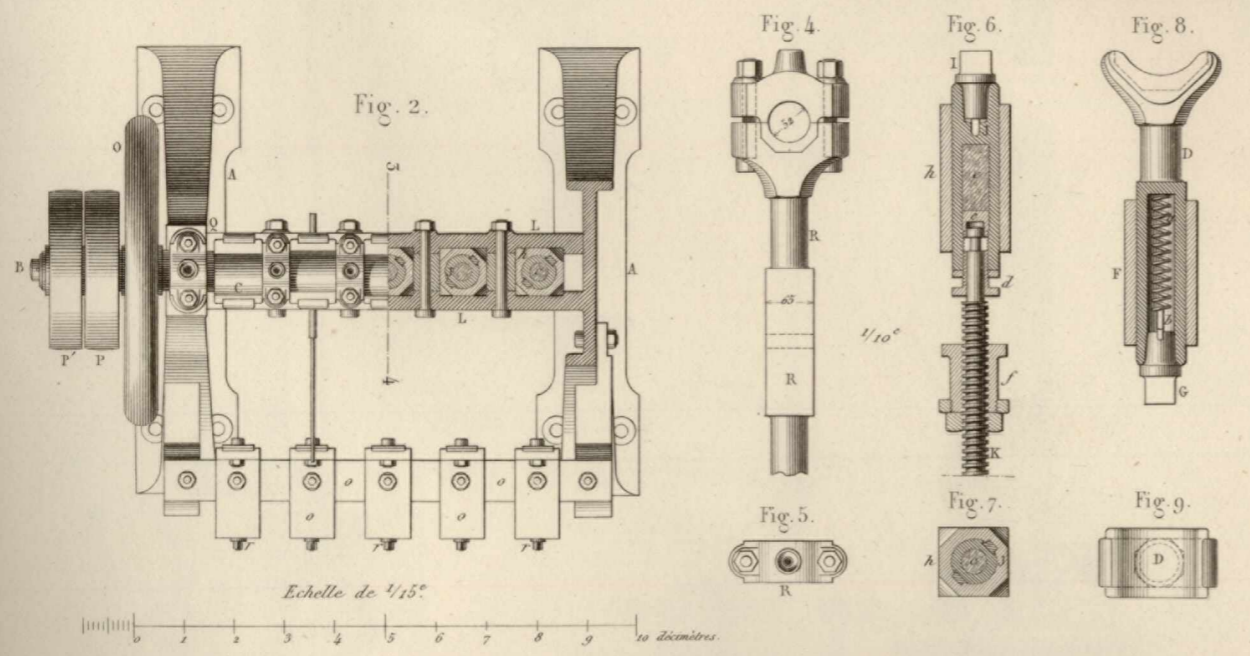
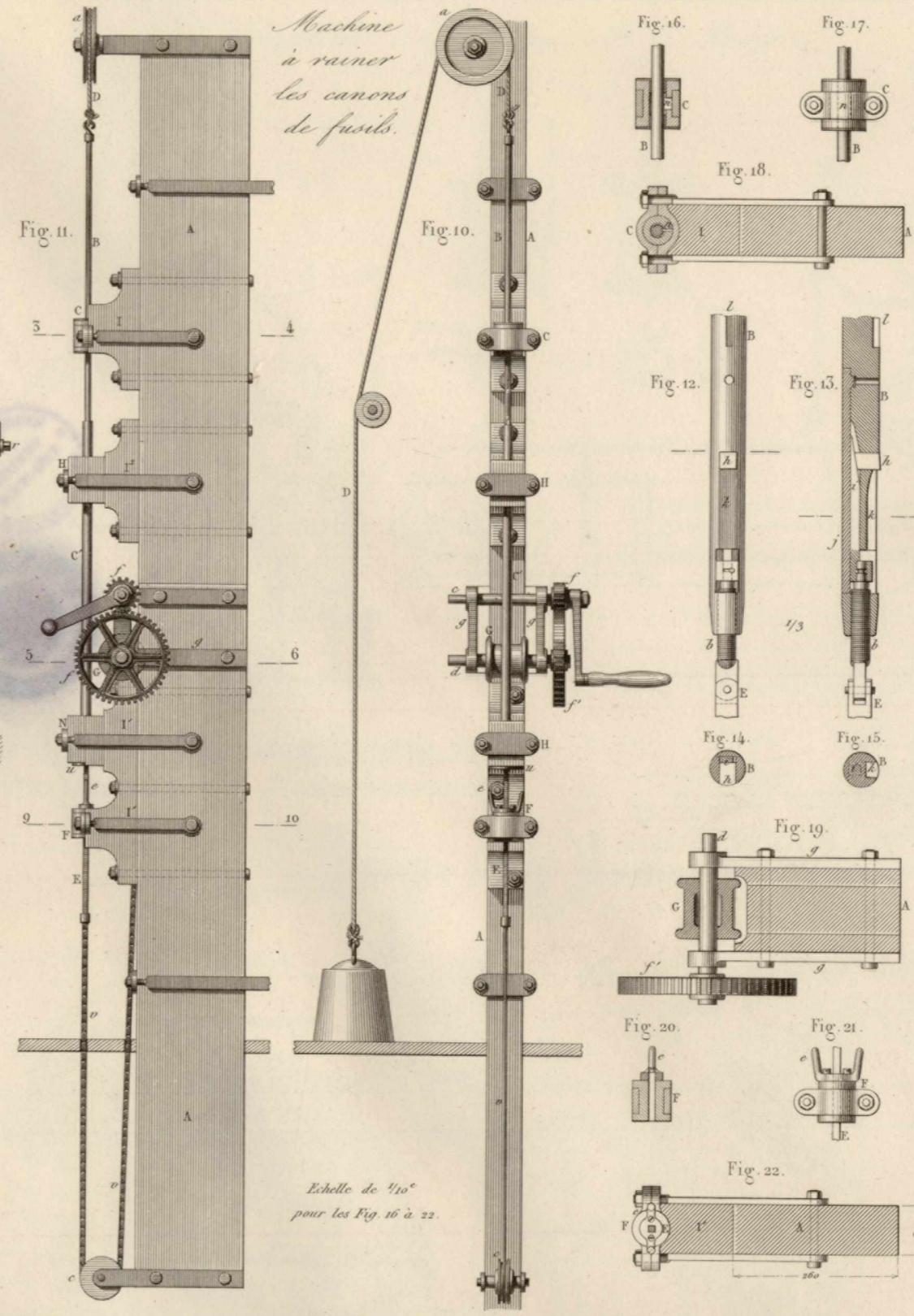

Echelle de 1/15^e
0 1 2 3 4 5 6 7 8 9 10 décimètres.

Echelle de 1/10^e
pour les Fig. 16 à 22.

Moderateur à compensation.
par M. Farcot.

Régulateur complexe. par M. E. Bourdon.

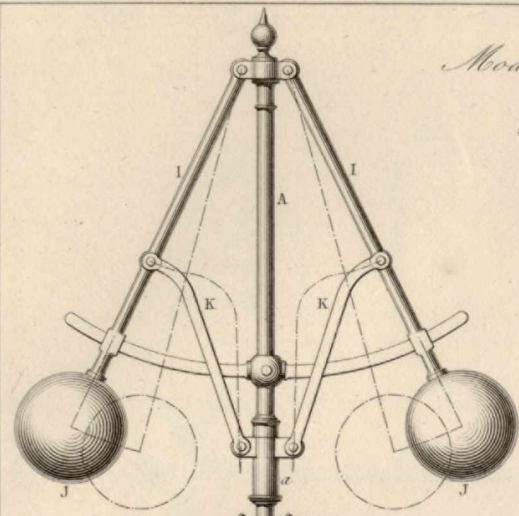

Fig. 1.

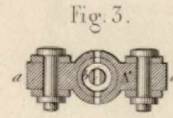

Fig. 3.

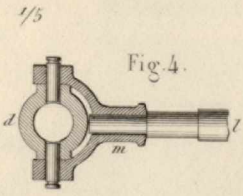

Fig. 4.

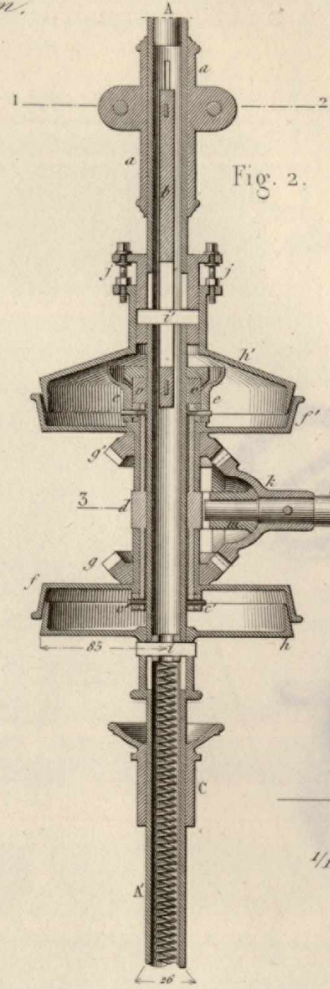

Fig. 2.

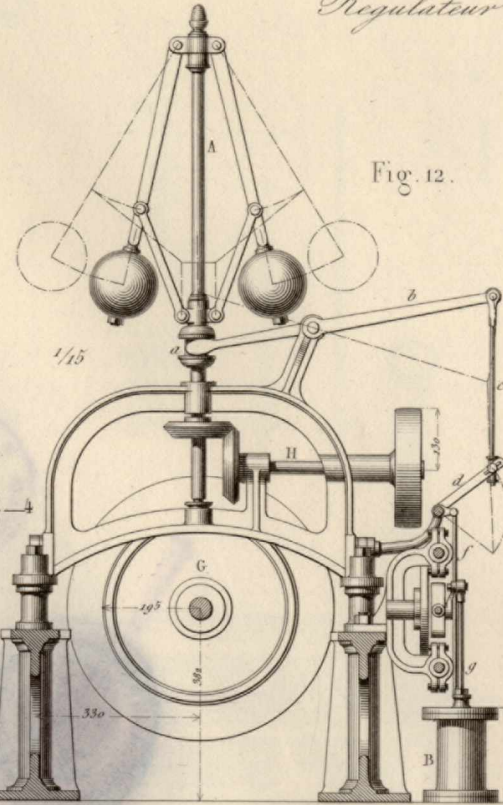

Fig. 12.

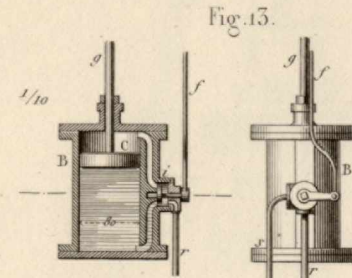

Fig. 13.



Fig. 14.

Fig. 15.

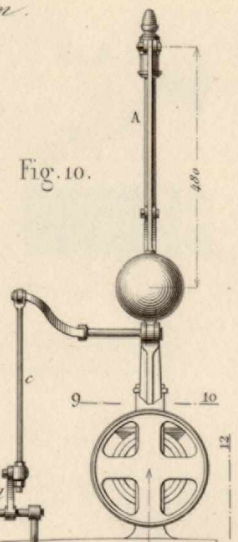

Fig. 10.

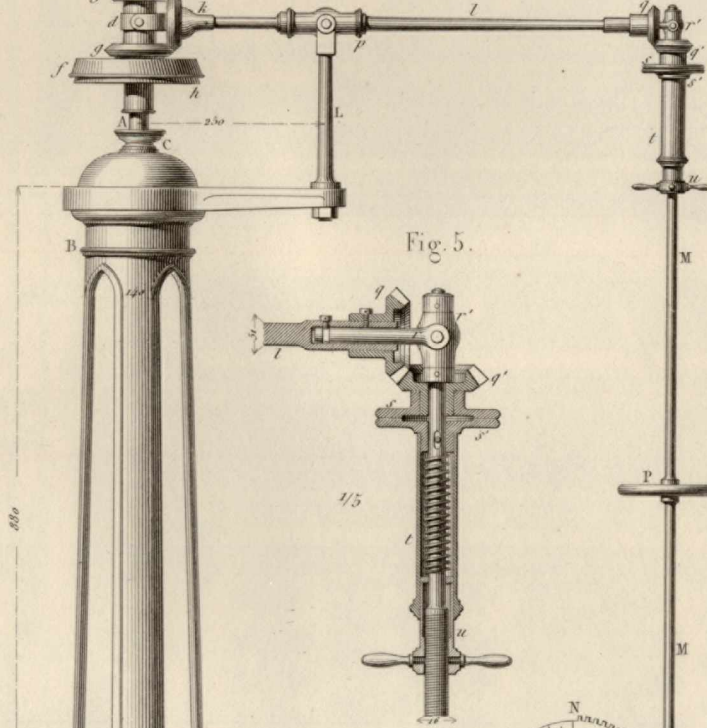

Fig. 5.

1/5

1/5

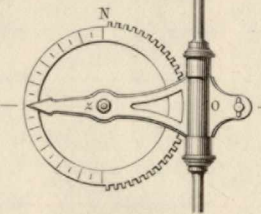

Fig. 6.

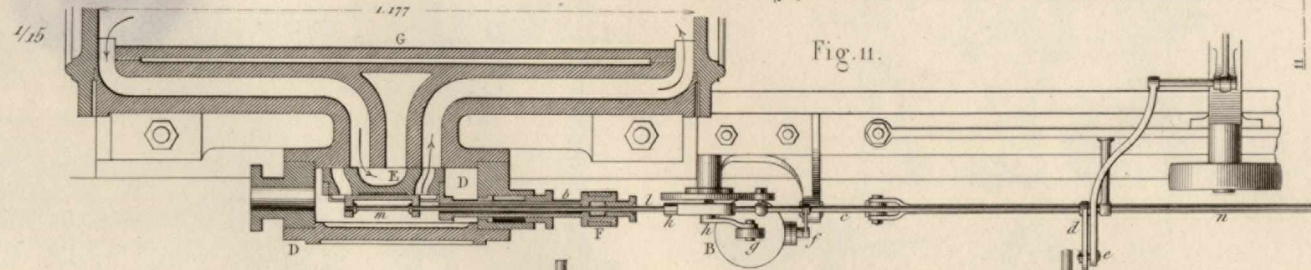

Fig. 11.

1/15

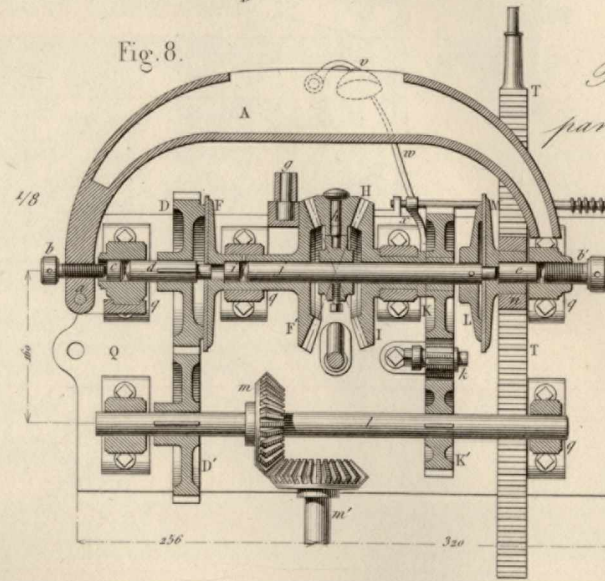

Fig. 8.

Régulateur à pendule
par M. Gast et Spets.

Fig. 9.

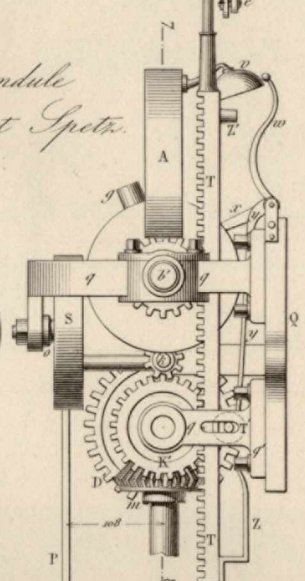
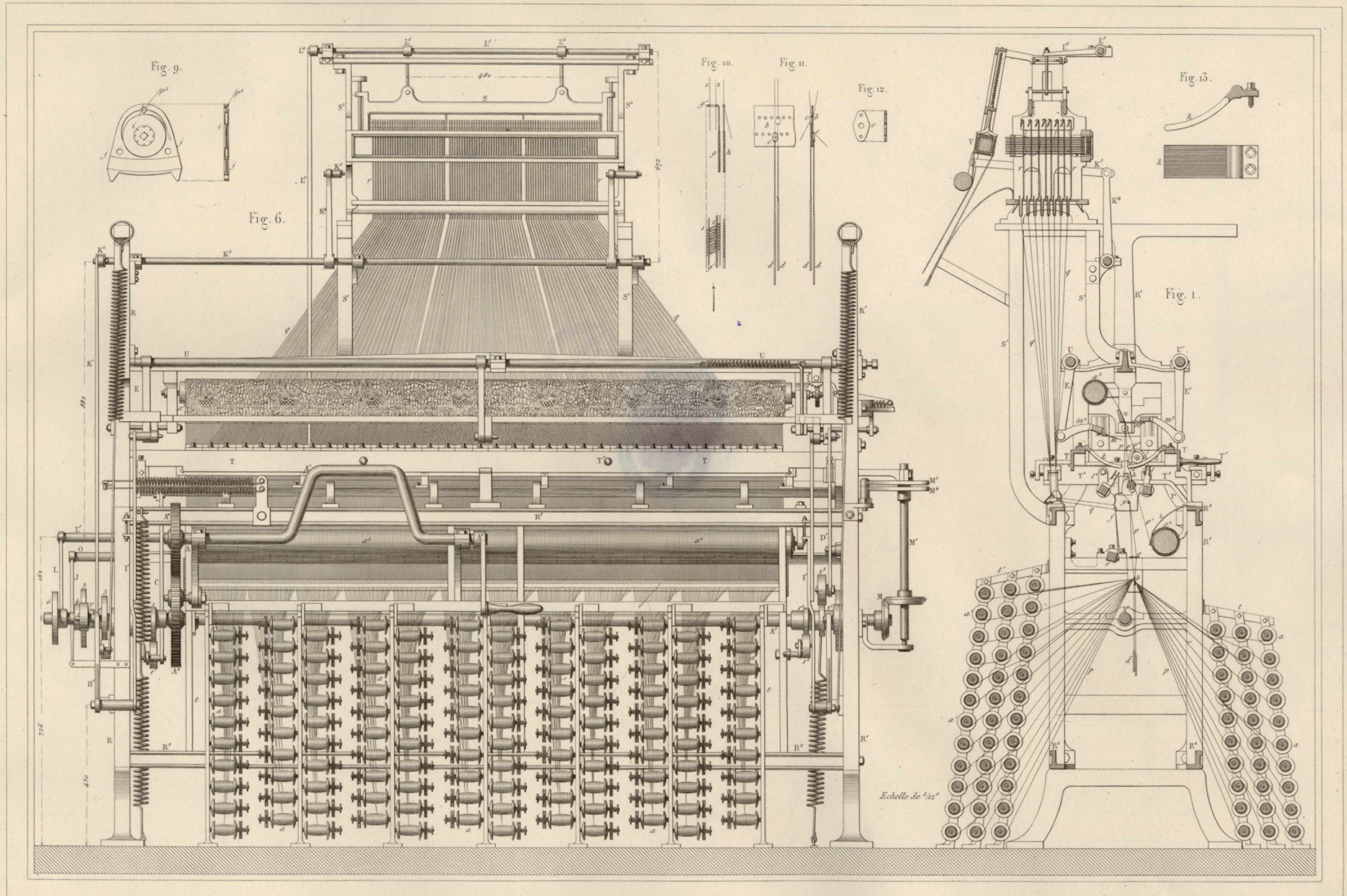

Fig. 7.

1/8

256

320



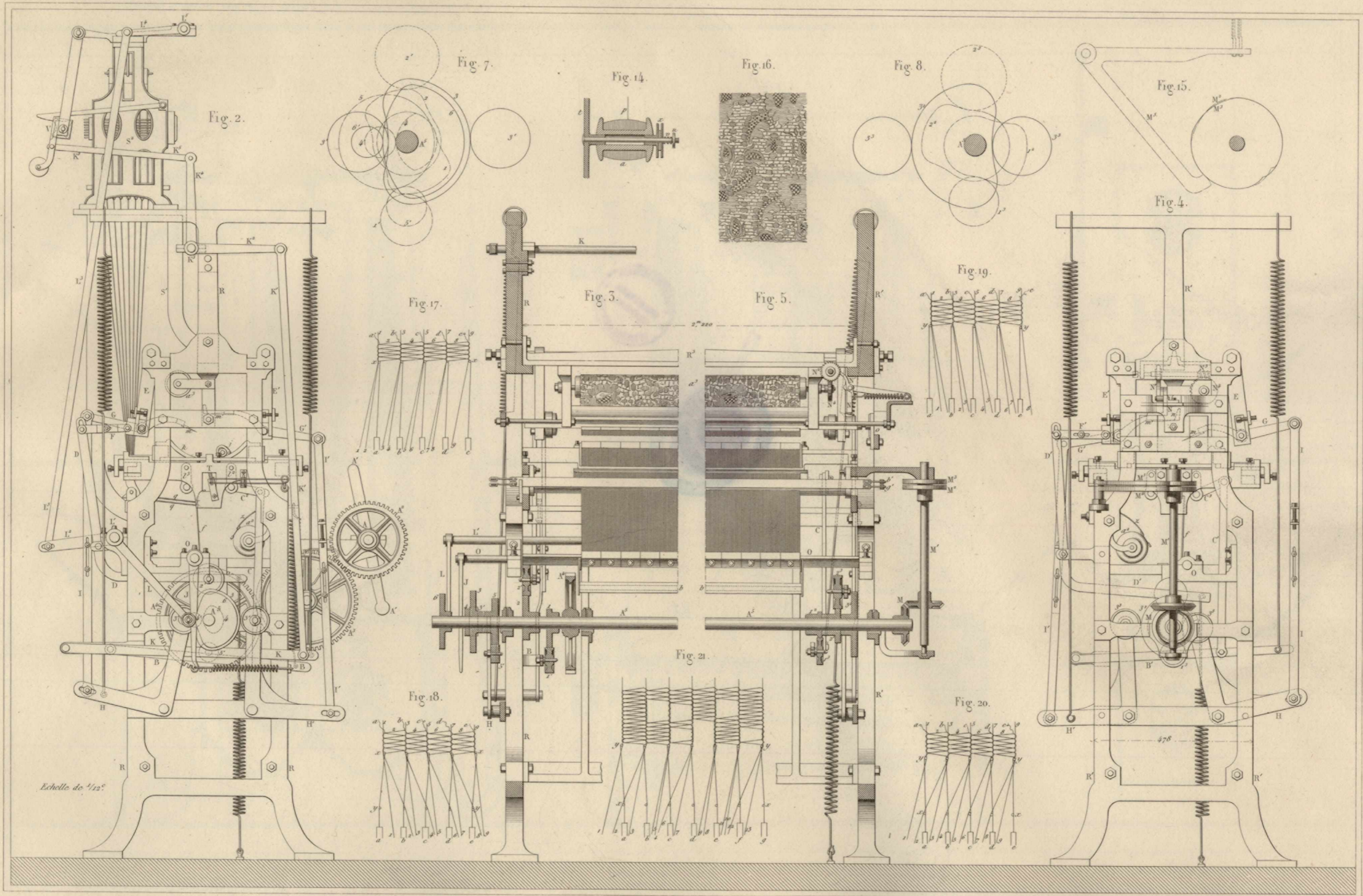

Echelle de 1/12^e

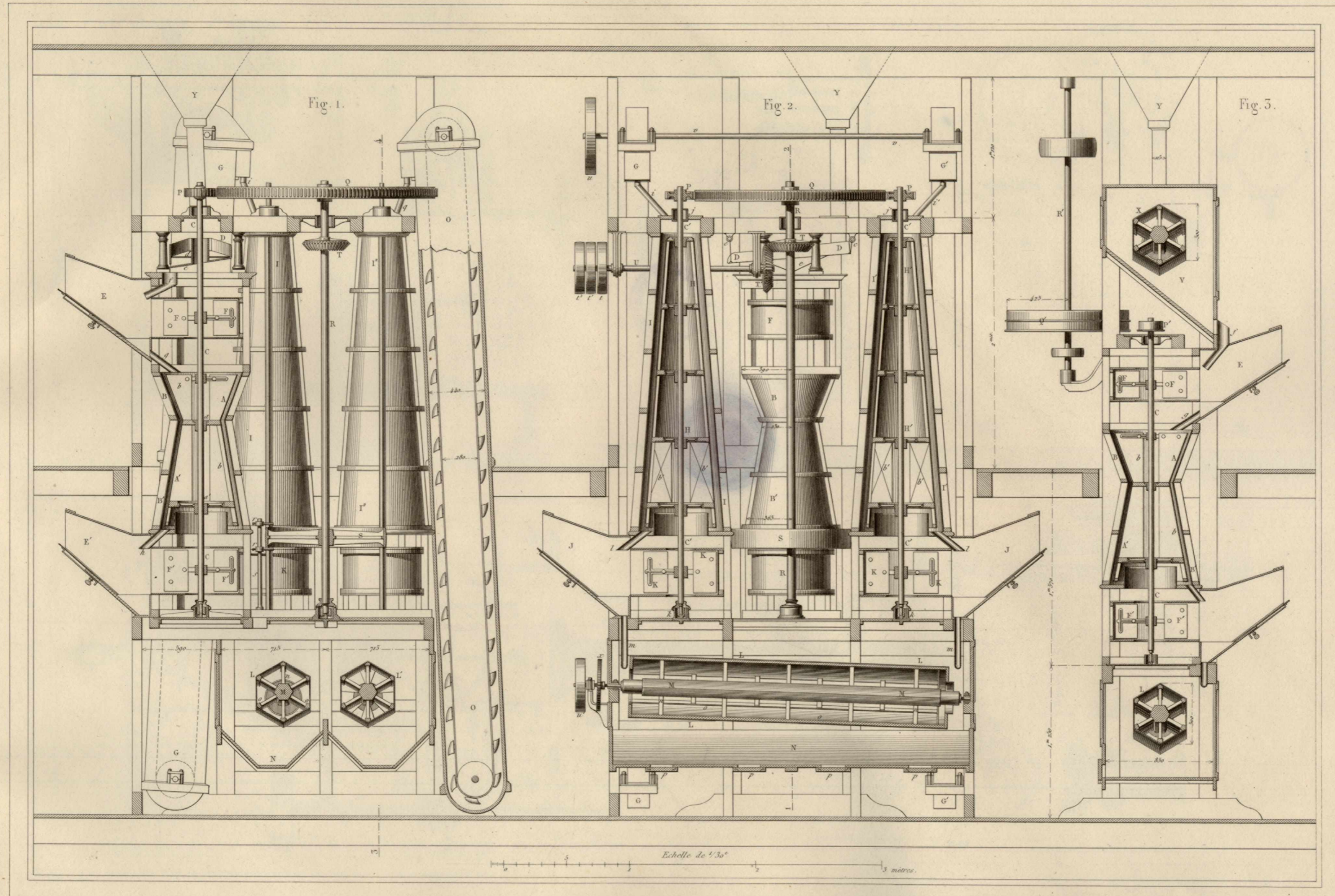

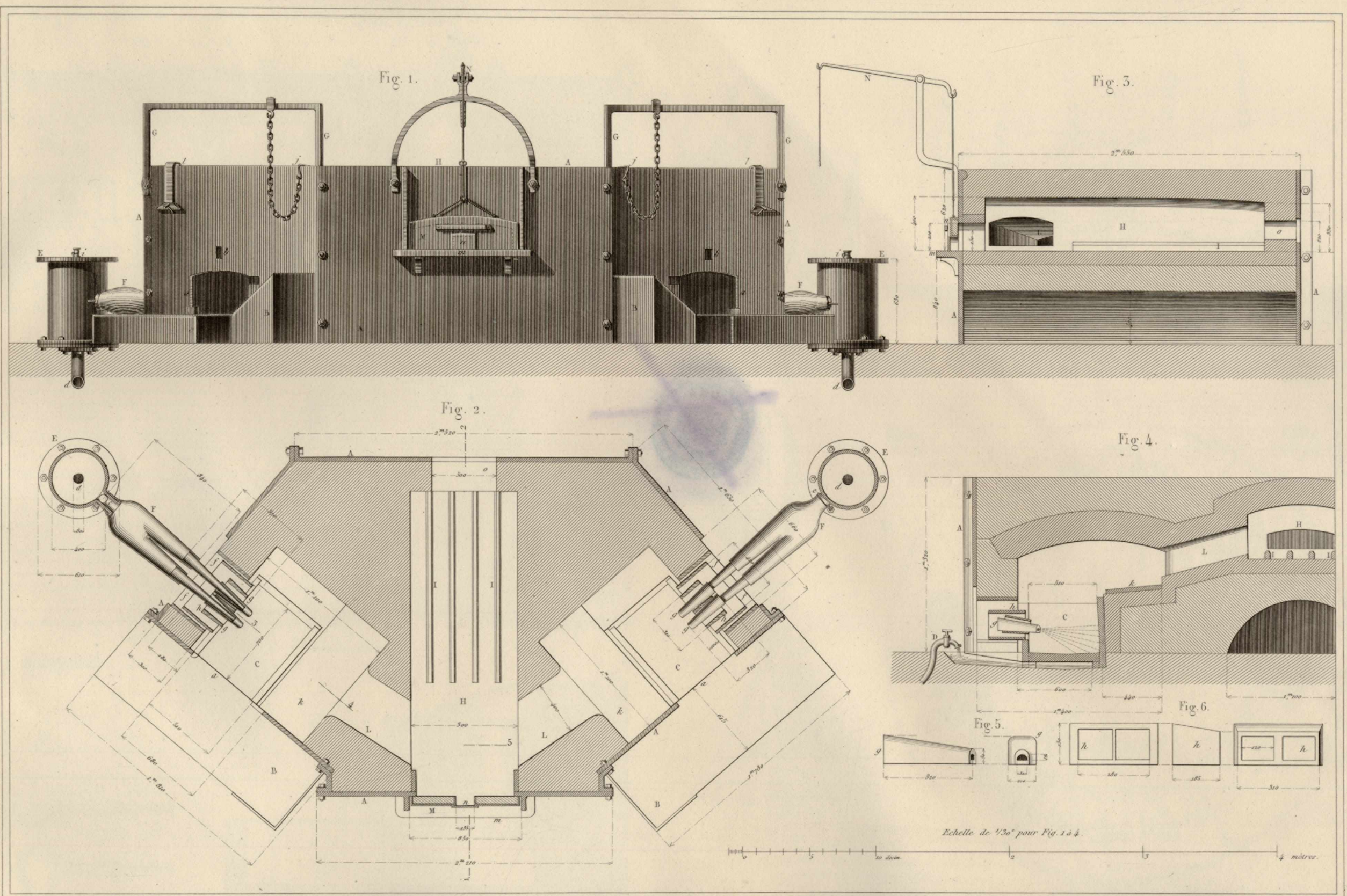

J. Petitcolin sculp.

Armengaud aîné.

Imp. de F. Chardon aîné, r. Hautefeuille, Paris

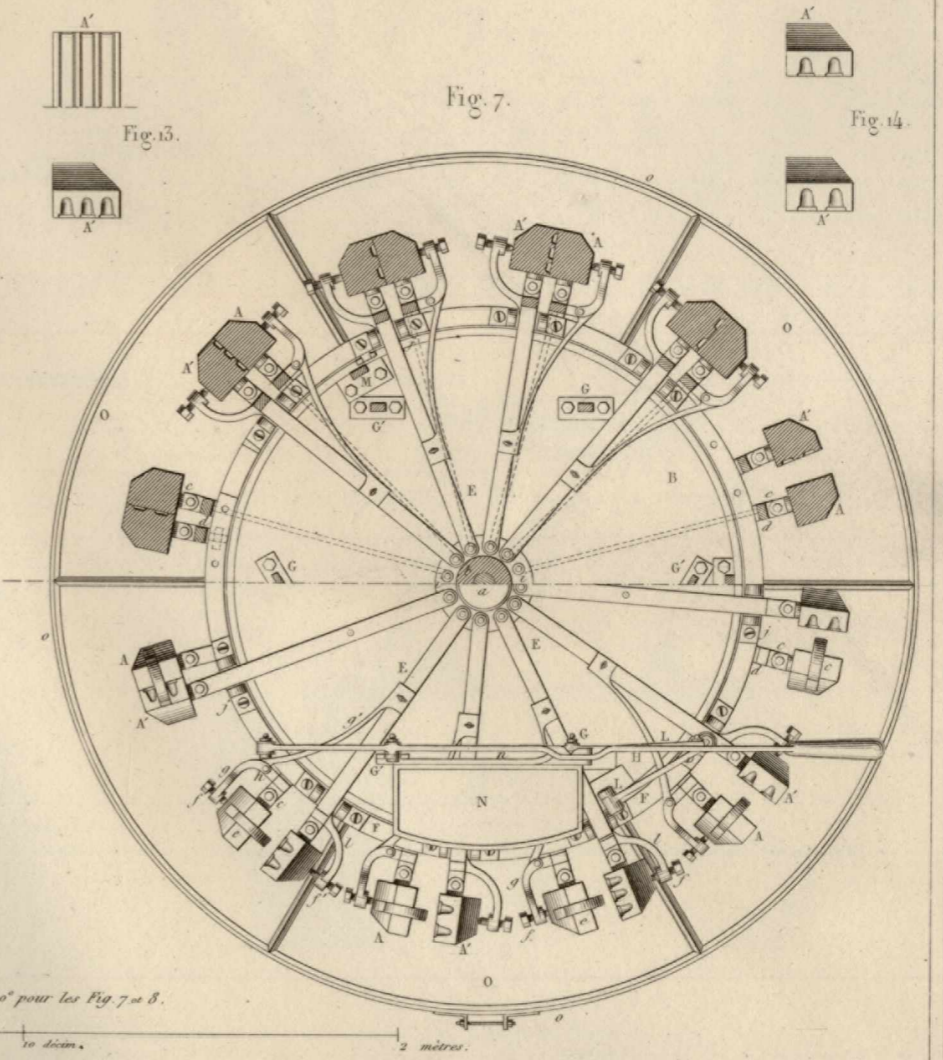
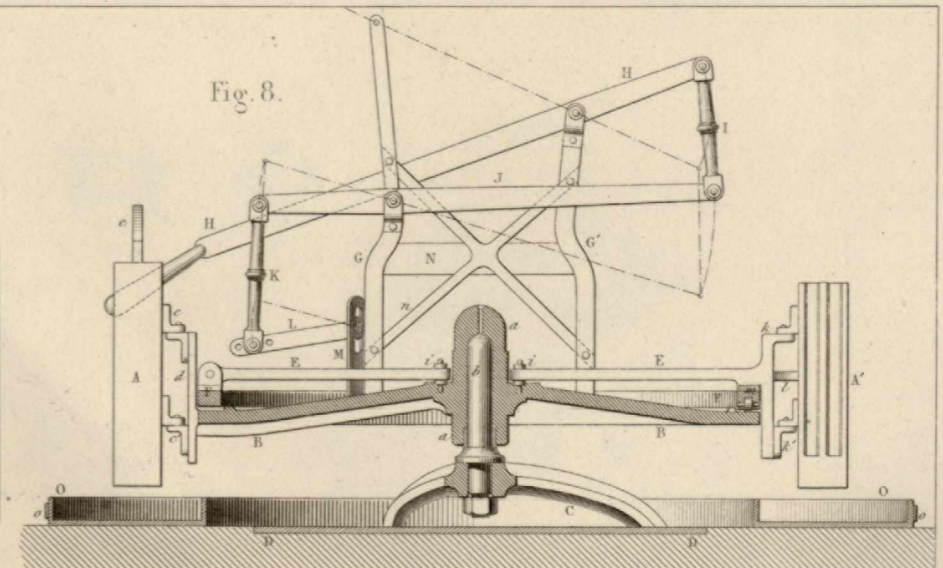
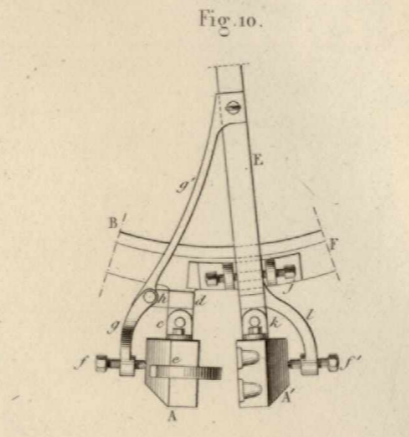
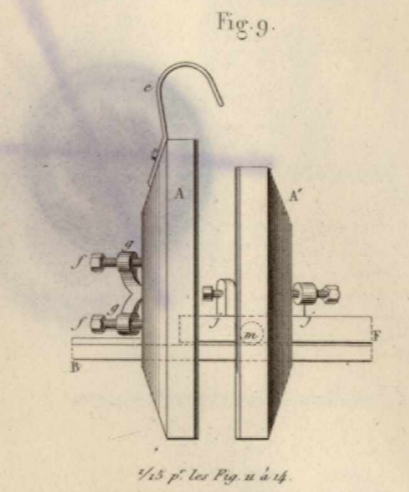
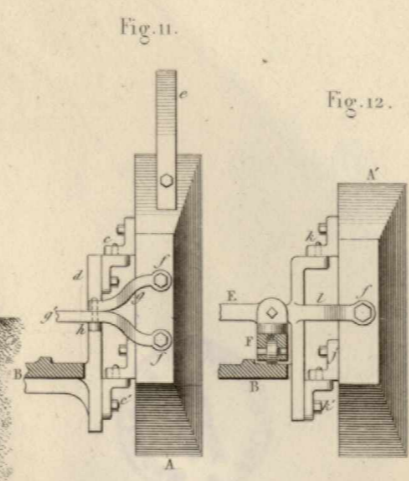
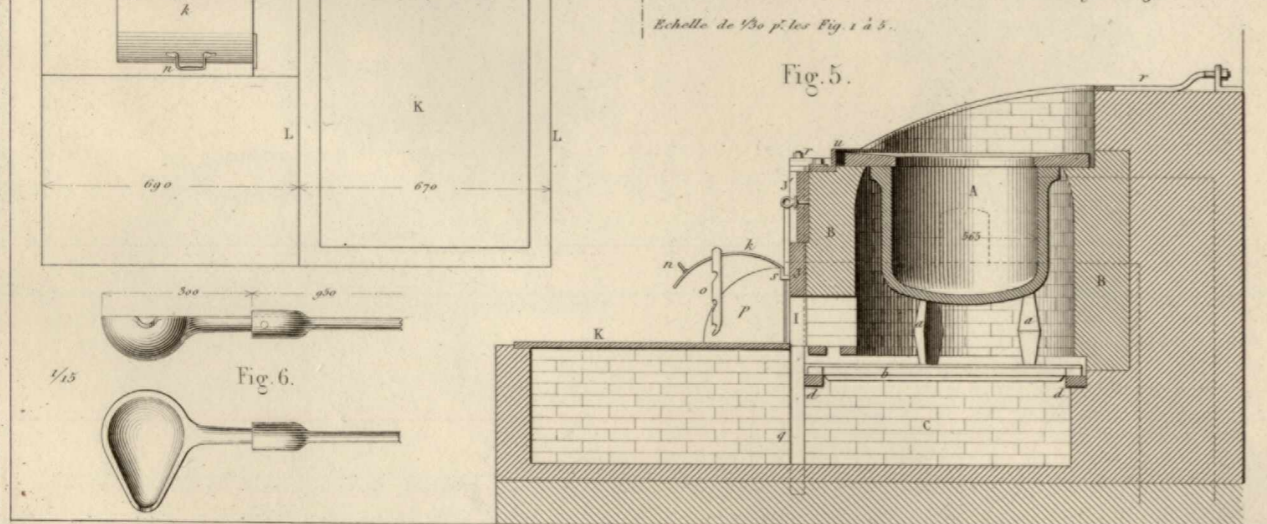
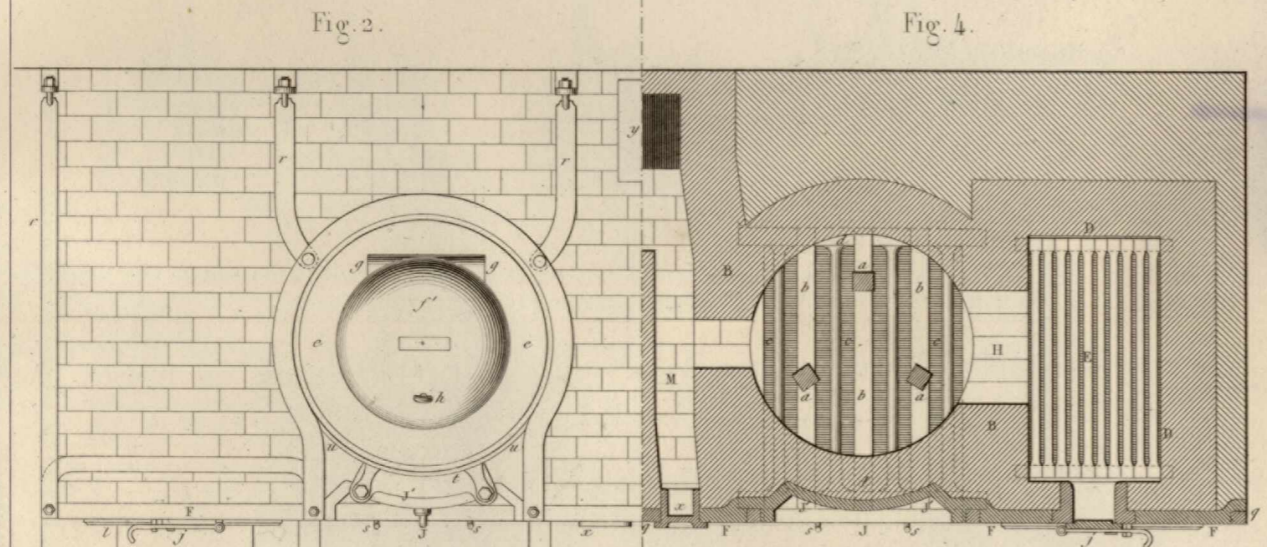
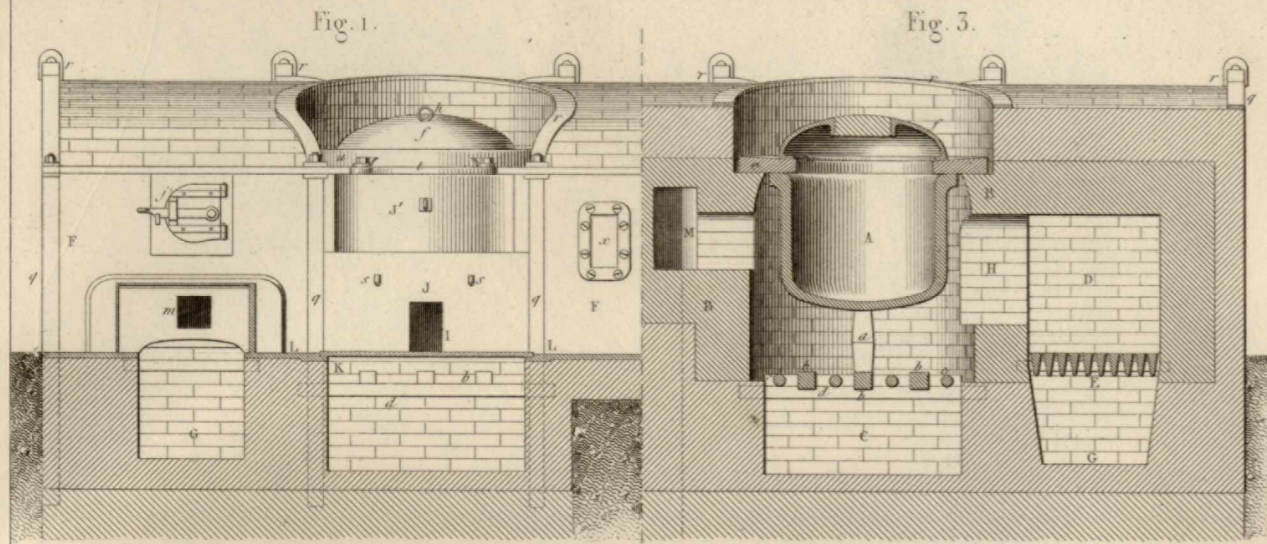

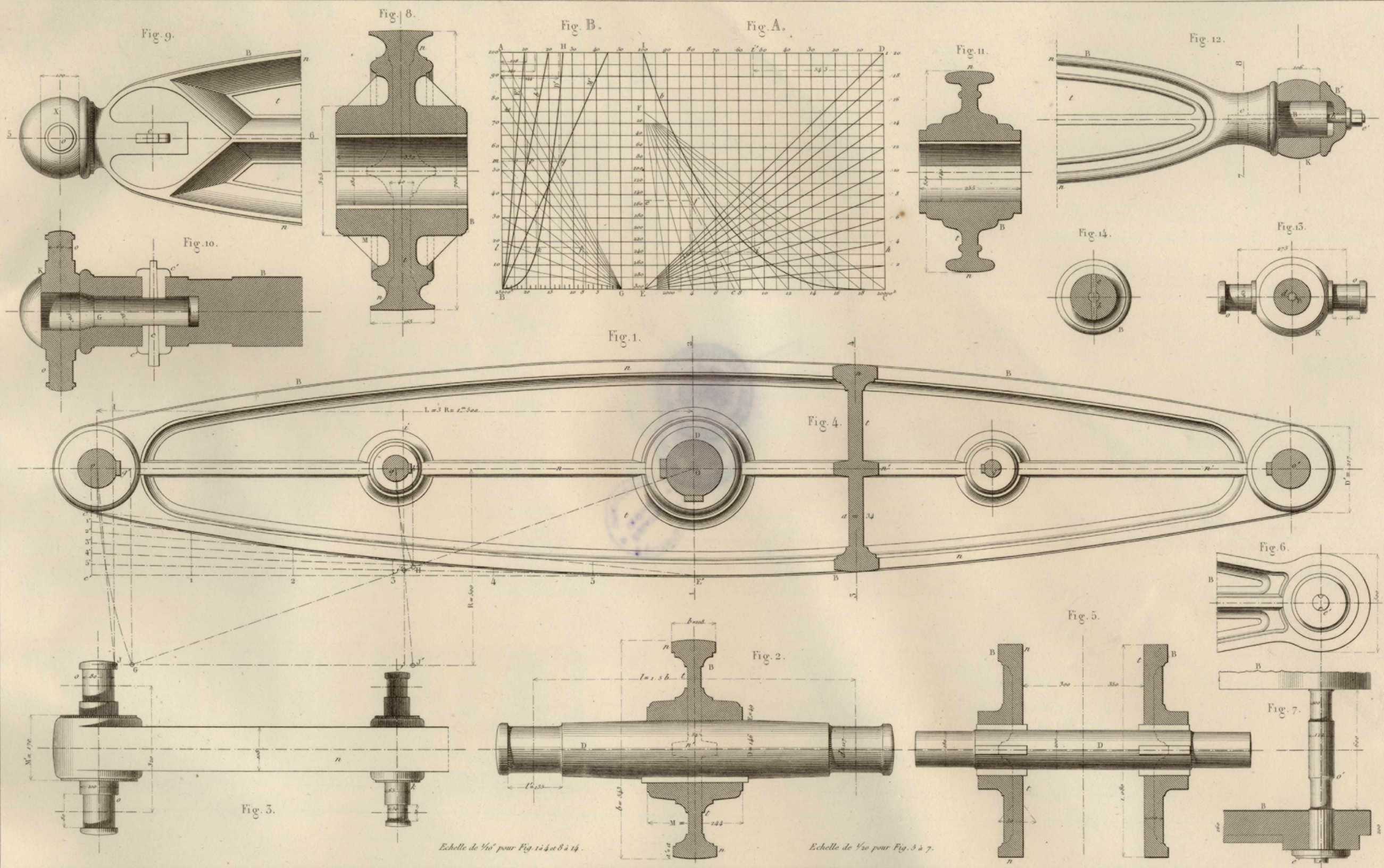

Echelle de 1/10^e pour Fig. 12 à 14 et 15.

Echelle de 1/20^e pour Fig. 3 à 7.

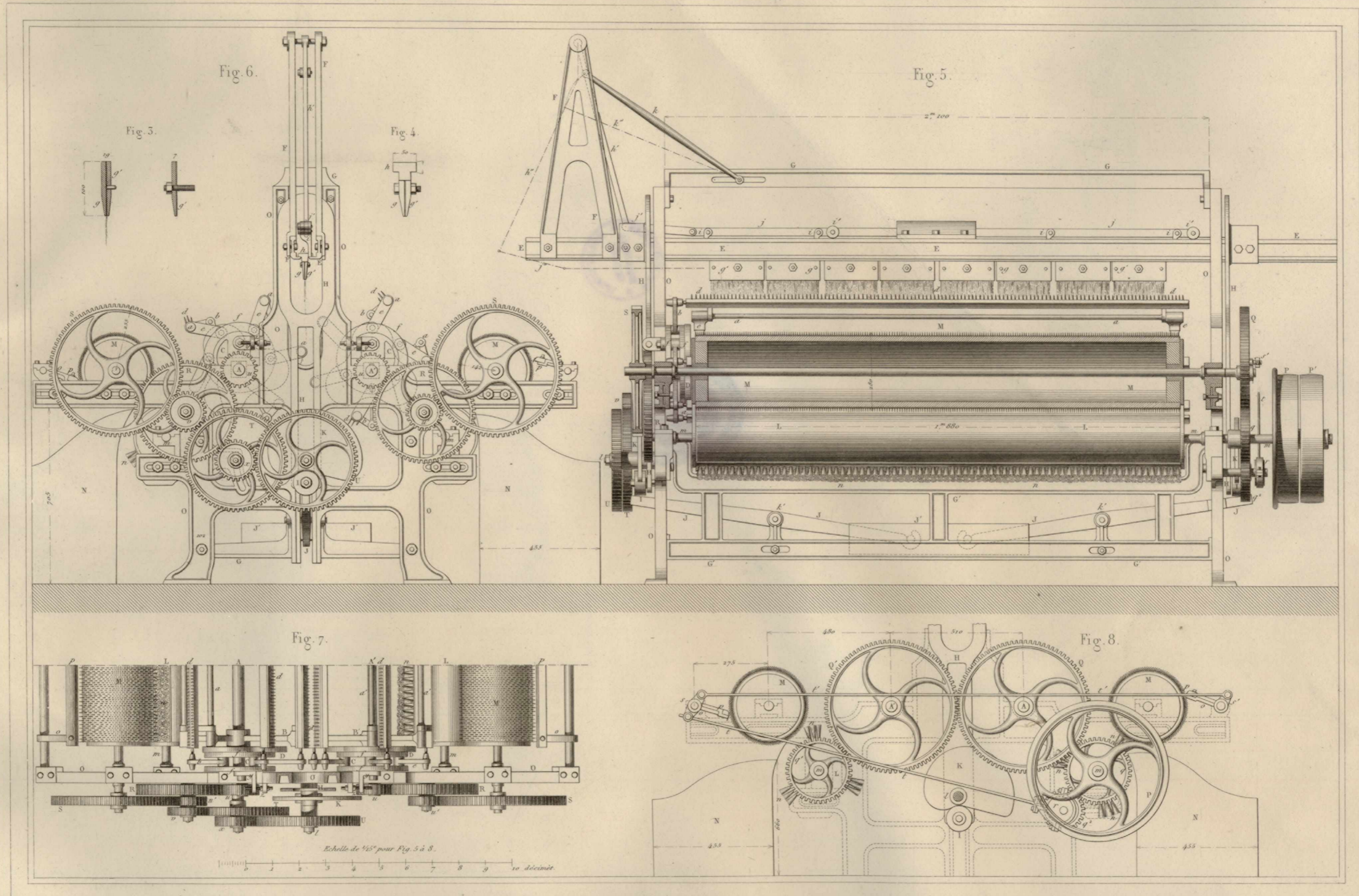

PEIGNEUSE CONTINUE
A PEIGNES EXCENTRIQUES.

Fig. 1.

Fig. 2.

Fig. 9.

PEIGNEUSE CIRCULAIRE
A PINCES TOURNANTES.

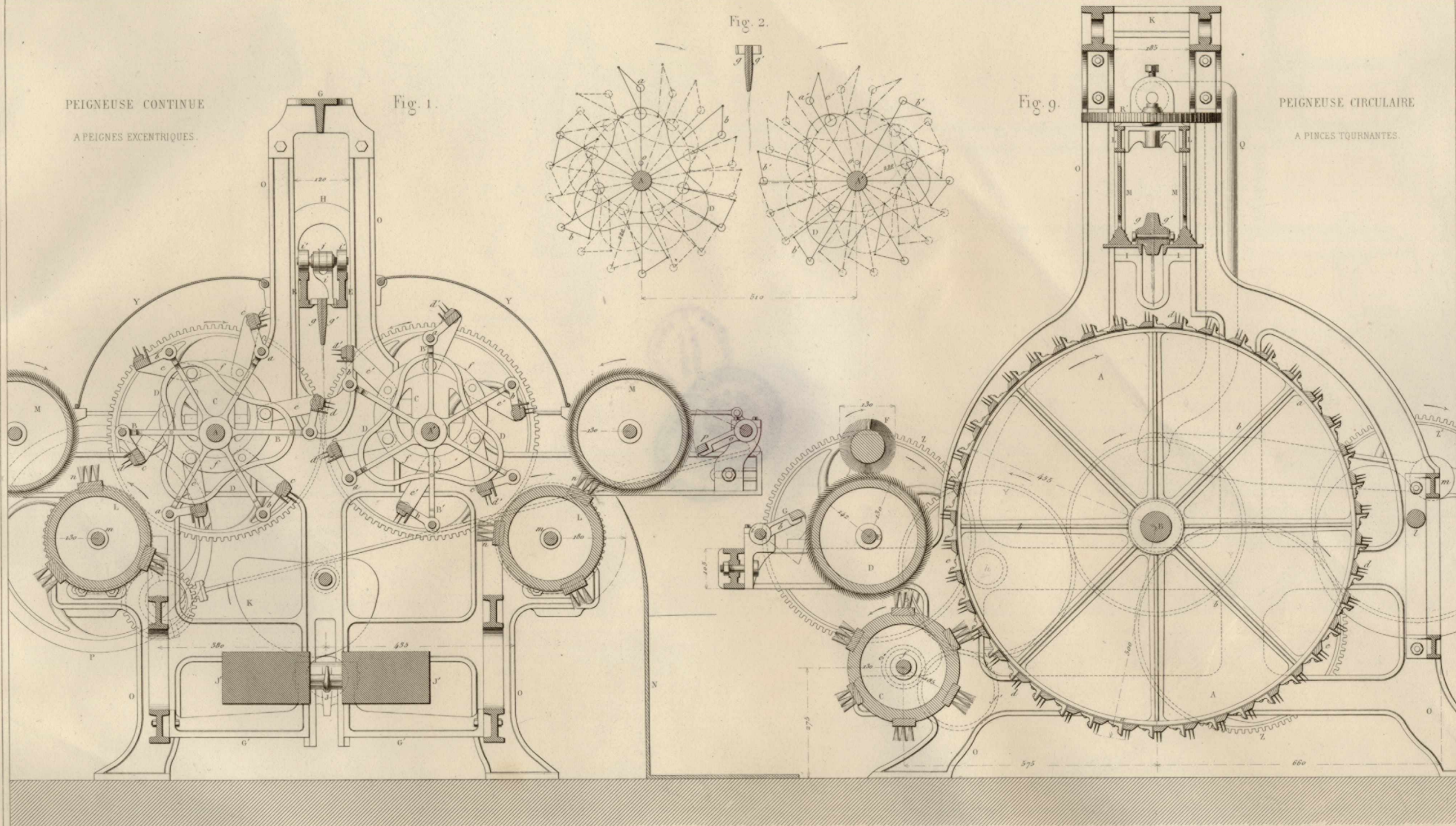

Echelle de 1/10

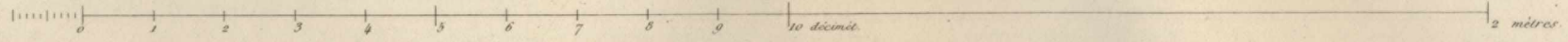

J. Petitcolin sculp.

Armengaud aîné.

Imp. de F. Chardon aîné, r. Hautefeuille, 30, Paris.

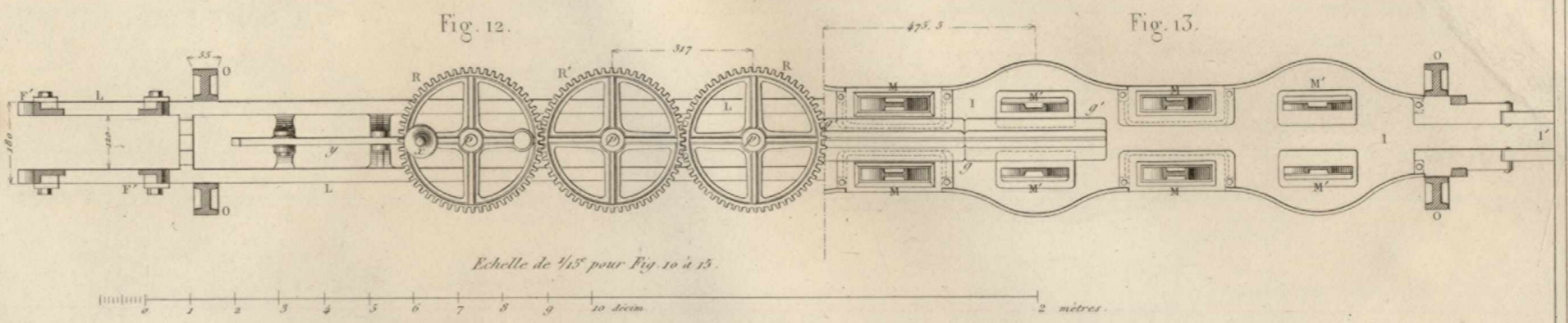
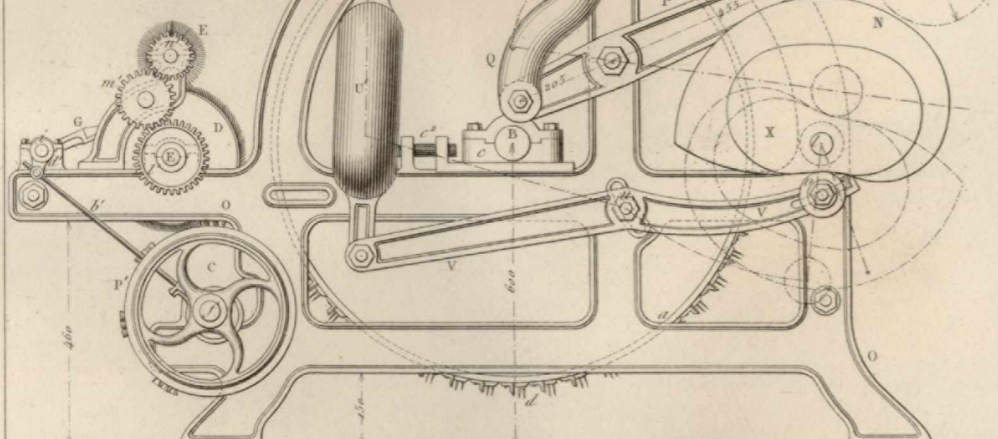
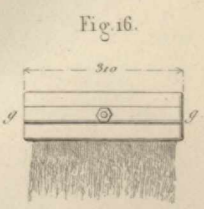
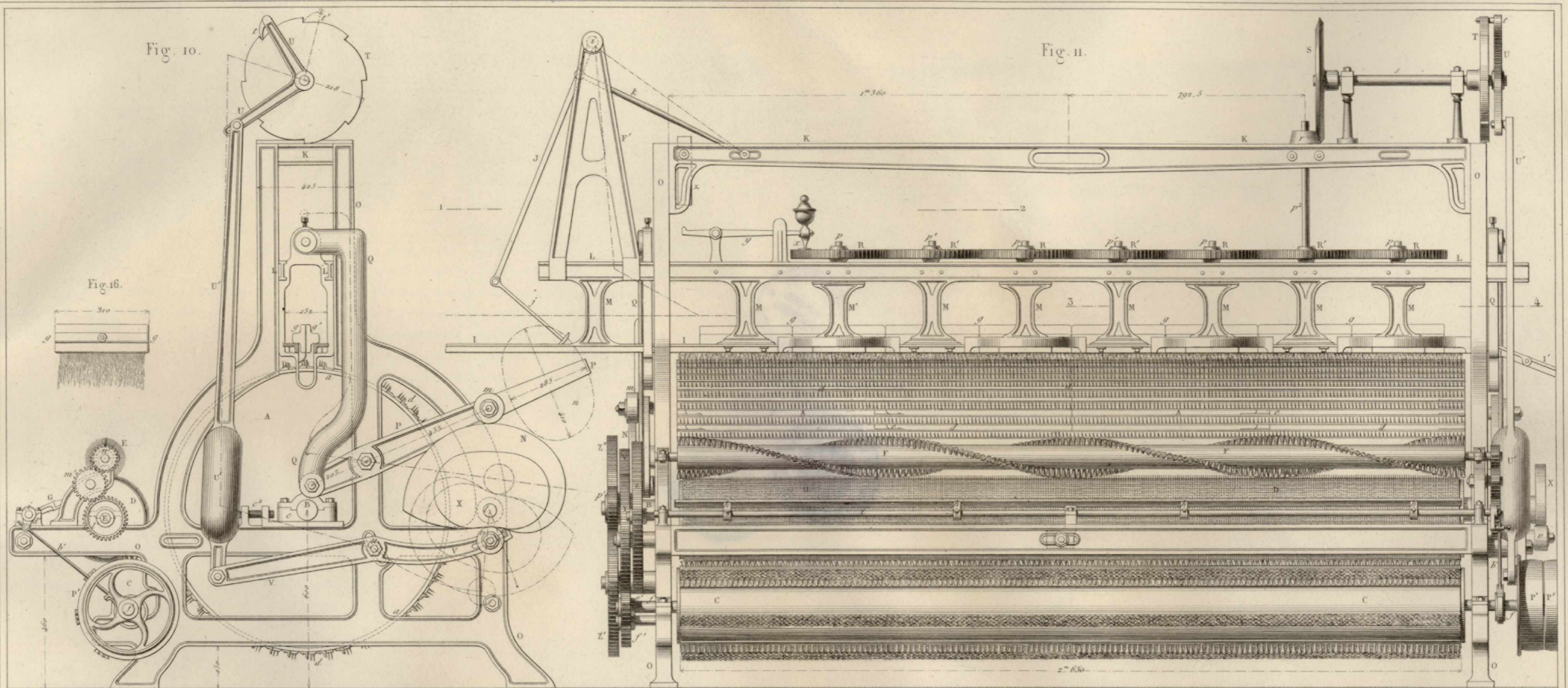

Echelle de 1/15 pour Fig. 10 à 15.

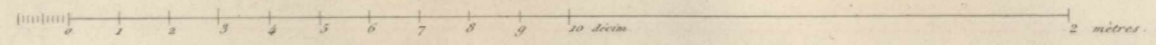

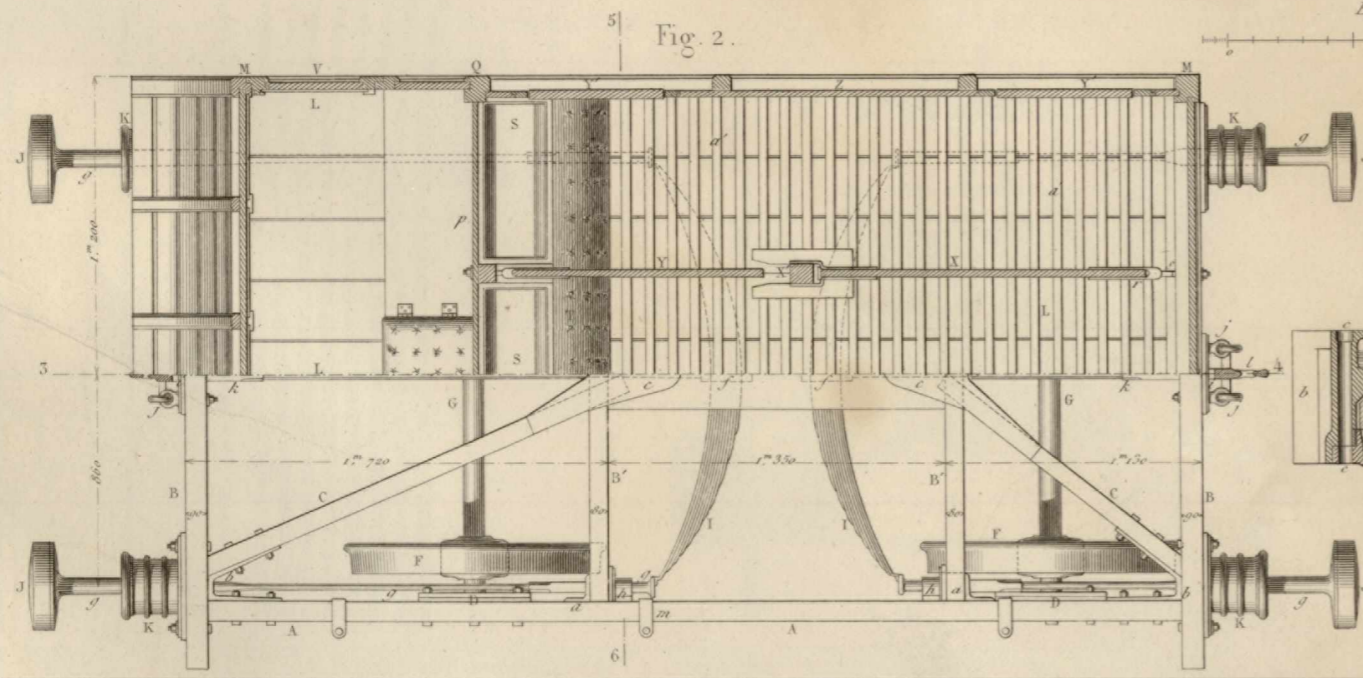
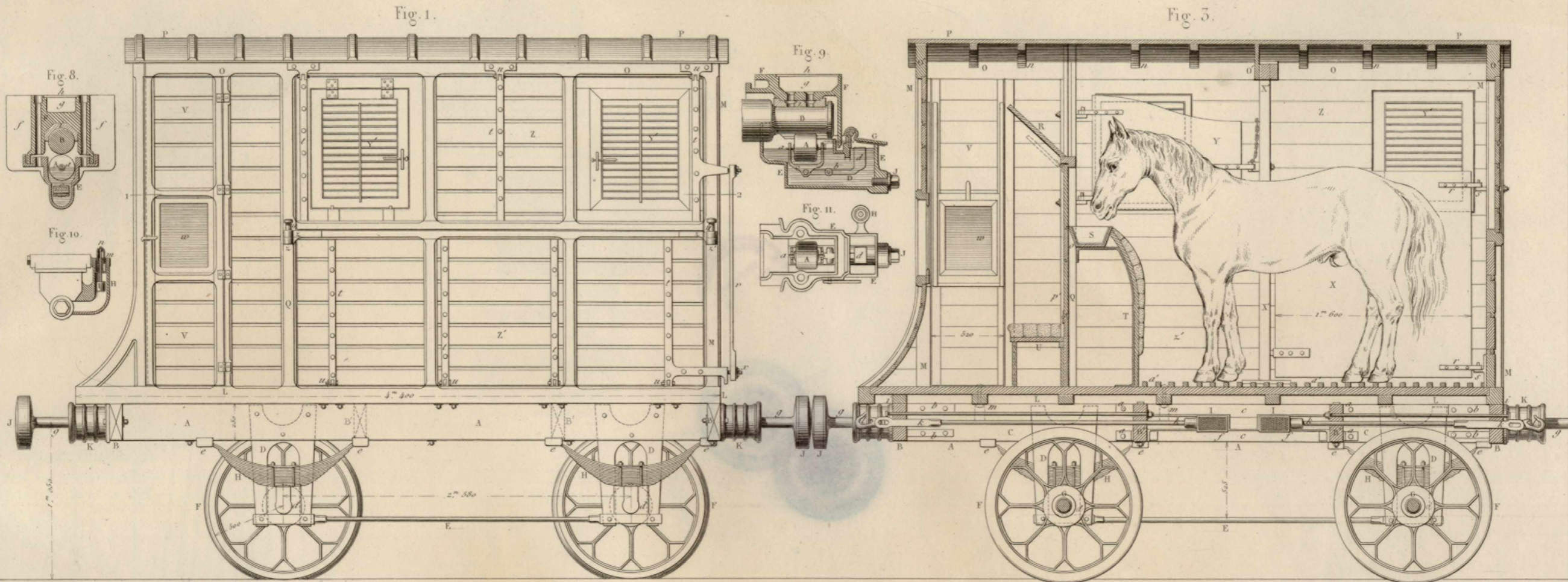

Echelle de 1/30 pour Fig. 1 & 2. 2 mètres.

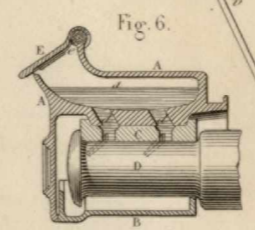
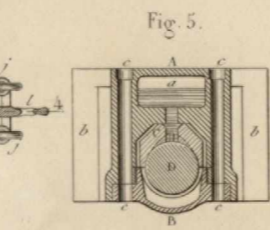
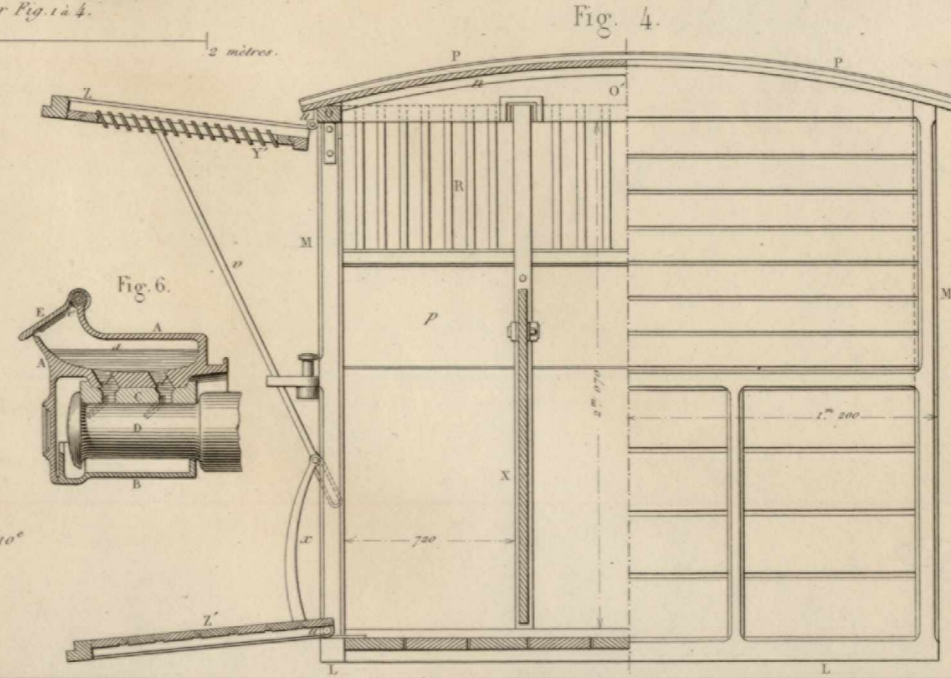

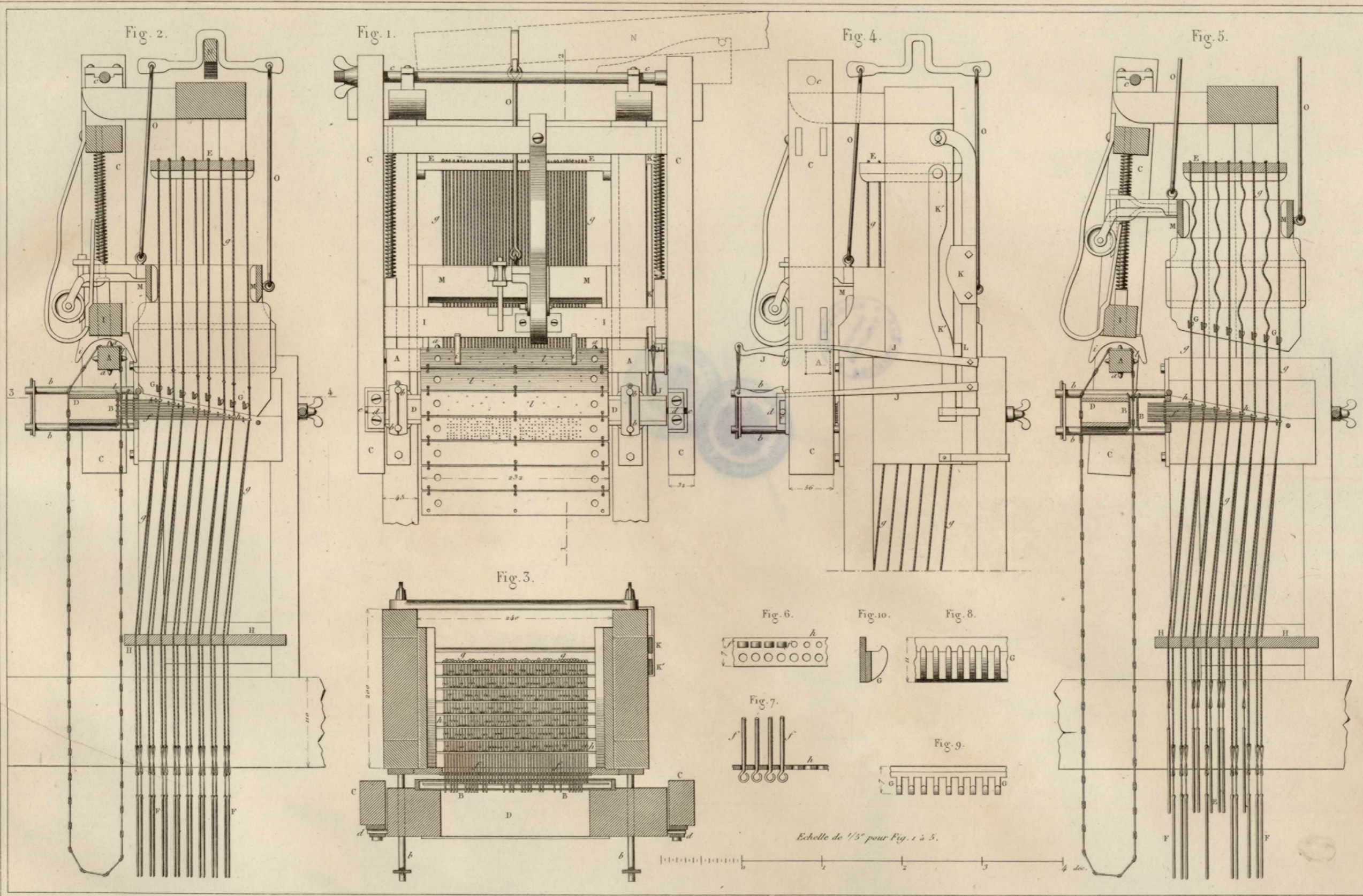



PRACOWNIA
KONSERWACJI
ZBIORÓW
SPECJALNYCH
BU WROCLAW
2009

