



Ulrich Schaaf*, Maciej Prarat**

Carpentry craft at the turn of the 18th and 19th centuries. Case study: the roof structure of the Church of the Holy Cross in Leszno

Introduction

The subject of this article is the roof structure from the turn of the 18th and 19th centuries over the Church of the Holy Cross in Leszno. The brick church itself was built in the years 1711–1715 on the site of the destroyed half-timbered construction. The roof structure that has survived to this day comes from the period when the church was repaired after a fire in 1790 when the interior was destroyed.

Its reconstruction was a great challenge for the parish, mainly owing to financial problems. The builders also faced a difficult task. Having limited financial possibilities, they had to build a bulky roof structure over a rectangular body with shallow, wide avant-corps in the longitudinal walls, with about 24 m clear width and 44 m clear length. This challenge was additionally made more difficult by an elongated octagon inscribed in the rectangle of the body, with about 14 m clear width and about 30 m clear length, that was to be vaulted.

These difficult conditions became the reason for an attempt at a closer analysis of the carpentry craft that was used to build the roof structure. This design has not met with the interest of researchers so far. It should be mentioned here that the construction of roof structures is the subject of studies [1]–[4], although a more detailed analysis of the layouts from the 19th century is rare. The applied research method consisted in determining its typology, and then the structural layout, carpentry joints, building material and its processing, and the system of carpentry marks.

The lack of access to the curved plank roof covering the inner octagon made possible only its general characteristics, without specifying details. Because of the limitations of the form of the article, the discussion of the roof construction above the shallow 3-sided avant-corps has also been omitted. It is less interesting in terms of typological solutions.

The Church of the Holy Cross in Leszno has already been the subject of scientific interest, on the part of Kohte [5], [6], Smend [7], Kręglewska-Foksowicz [8], Kuztelski [9], Harasimowicz [10], [11], and Urban [12] among others. However, none of the researchers referred to the building technique of the roof structure. The only publication that discusses the history of transformations in more detail was issued on the occasion of the building of the church tower's helmet in 1909–1910 by the then pastor of the church [7]. In this text, the history of the building and repair of the roof structure from the end of the 18th century to the 2nd half of the 20th century will be presented first, and then the technique used in its building at the turn of the 18th and 19th centuries will be presented in more detail.

History of the building and repair of the roof structure from the end of the 18th to the 2nd part of the 20th century

A study of the sources and literature on the Church of the Holy Cross and the analysis of the building technique of the existing material substance of the roof structure [13], [14] made it possible to distinguish between two basic building phases. The first phase is the building of the roof structure in the years 1798–1802, while the second one is related to various repairs that took place after the middle of the 20th century.

* ORCID: 0000-0003-3055-1009. Faculty of Fine Arts, Nicolaus Copernicus University in Toruń, Poland.

** ORCID: 0000-0001-7076-2009. Faculty of Fine Arts, Nicolaus Copernicus University in Toruń, Poland, e-mail: mprarat@umk.pl

Building the roof structure in the years 1798–1802

After the fire in 1790, building inspector Haerber carried out a building inspection in 1794. Owing to the long distances between the pillars and the poor load-bearing capacity of the lateral walls, he recommended replacing the planned brick vault with a false vault made of boards and reeds. He also added that with such a solution the roof did not have to be so steep and that it would be cheaper [7, pp. 49, 50].

Masonry work was carried out until 1796. In the same year, however, the reconstruction was interrupted due to the lack of funds, and the cornices and pillars were temporarily secured. In 1797, the parish decided to continue the reconstruction and decided that the new roof was to be covered with tiles because sheet metal was too expensive. Moreover, it was decided that the interior of the church was to be closed with a false vault covered with plaster. The works were entrusted to building inspector Dulitz from Wschowa, who estimated the costs at 8,000 thalers [7, p. 50].

In 1798, a tender for carpentry works was announced, but owing to the lack of funds, it was not completed. In that situation, the parish asked the king to make possible a national collection. However, it was refused. In return, the parish was promised the necessary building material as a donation, which was estimated at 593 pieces of wood, but it was abandoned after a short time. It was subsequently agreed that the parish would receive wood from the Włoszakowice forests for less by 1/8 than the charge, but that plan turned out to be impossible to implement, as that royal forest did not have the appropriate building material for the building of the roof structure. Finally, the parish received compensation of 250 thalers and an additional 400 thalers in place of the rejected collection [7, p. 50]. At the same time, the parish rejected inspector Dulitz's design of a plane-tile roof in the crown, estimated at 11,417 thalers, and approved a curved plank roof with boards for 8,954 thalers [7, p. 51].

Over the subsequent years, the parish was preoccupied with the purchase of the necessary building material. Among other things, 400 pine trunks were purchased from Countess Turno from the Radomice forests. Under the supervision of building inspector Dulitz, the wood was selected and marked in the forest, and under the supervision of carpenter Wagner, it was felled and hewn on site. After the parish's supplication, landowners and farmers from nearby transported the wood to the construction site free of charge [7, p. 51].

After paying for the timber, the parish lacked funds to continue the work, and therefore, in 1801, the church was in the same condition as it was in 1796. 4,000 thalers were lacking to complete the work. The supplication of the city magistrate, addressed to the king in this matter, was refused. At the end of March 1801, the members of the parish decided to take a loan and declared that they would share the obligation to pay it back in order to complete the construction of the church [7, p. 52].

After receiving the loan, the last three pillars were erected in accordance with the proposals of the building

inspector, namely Dulitz and the roof structure was made as a king post structure covered with sheet metal and a wooden "vault" over the interior of the church. Owing to the lack of funds, initially only the northern side of the roof was covered with sheet metal, and the remaining areas were temporarily covered with tiles [7, p. 53]. Since doors and window frames were made in 1802, stairs in 1803, and plaster in the interior of the church in 1804 [7, p. 53], it should be concluded that the works related to the roof structure and its covering ended in 1802. This supposition is confirmed by an inscription on one of the jack rafters (1802).

Roof structure repairs since the 2nd half of the 20th century

The sources and literature on the subject contain both a great deal of information about the poor condition of the church roofing, as well as about the repair or replacement of this roofing in the period from the construction of the roof structure at the turn of the 18th and 19th centuries to the 1970s [7, pp. 58–60], [15, pp. 238, 288, 293, 299]. The performance of these works is also confirmed by the inscriptions on some structural elements. The literature [7] and later sources show that they did not cover the repair of the roof structure itself. There are also no traces of material repairs since the mid-20th century.

On the other hand, the poor condition of the roof or the whole church and the need for its renovation is mentioned in various writings from the 1960s and 1970s [15, pp. 241–245, 250, 251, 256–262, 264, 269, 271, 272, 276, 277, 280]. However, the repair of the roof structure probably took place at the turn of the 1970s and 1980s, after the church was taken over by the Roman Catholic parish [16]. At that time, the single, damaged ends of the binding beams and sections of the trusses were replaced with steel channel sections and some of them were replaced in their entirety. Perhaps at that time, some elements of the inclined standing queen-post frames were also removed. The replacement of the elements secured with one-sided logs or tongs seems to be more recent, as is suggested by, among other things, a different repair method, different metal fasteners, and different impregnation [13]. The period of securing most carpentry joints with dogs remains an unresolved issue.

The analysis of the existing wooden roof structure has shown that despite these repairs, it has largely retained its original character, discussed in detail later.

The carpentry craft of the roof structure

System and structural layout

To solve the difficult task – the construction of a roof structure over a large rectangular body with an elongated octagon inscribed in it, which is to be vaulted – a complicated, mixed construction system was used (Fig. 1).

Above the inner octagon there is a false vault in the form of a curved plank roof. This structure is independent, but owing to the large span – about 14 m – and the small

dimension of the arch rise – about 1.5 m, many curved planks were suspended in addition to the various wooden elements of the truss above (Fig. 2).

The actual roof structure with a span of 24 m is a collar beam structure, free (within the apparent vault), with inclined standing queen posts on the lower tier and a hanging king post truss on the upper tier. The straining beam for the inclined standing queen posts of a significant length (about 11.00 m) is additionally supported on the lower tier

with two passing braces. Thus, it forms a strut frame. Two passing braces on the lower tier and in their extension, first two short braces between the straining beam and the collar beam, and then two other passing braces on the upper tier additionally support the king post, as in the case of the hanging and strutted frame. In addition, between the pillars of the internal elongated octagon on the southern and northern side, there are hanging king and queen post structure frames, the trusses of which are suspended with

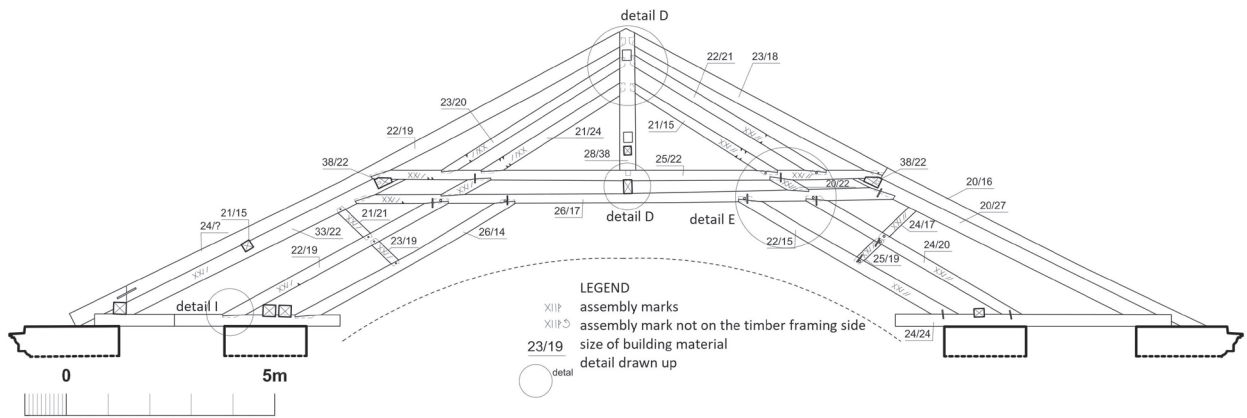

Fig. 1. Leszno, Church of the Holy Cross, roof structure, principal rafter truss (elaborated by U. Schaaf, M. Prarat)

Il. 1. Leszno, kościół św. Krzyża, więźba dachowa, więzár pełny (oprac. U. Schaaf, M. Prarat)



Fig. 2. Leszno, Church of the Holy Cross, roof structure, curved plank roof, curved planks suspended from the structural elements of the roof structure above (photo by U. Schaaf, M. Prarat)

Il. 2. Leszno, kościół św. Krzyża, więźba dachowa, konstrukcja krążynowa, krążyny podwieszane do elementów konstrukcyjnych więźby dachowej powyżej (fot. U. Schaaf, M. Prarat)

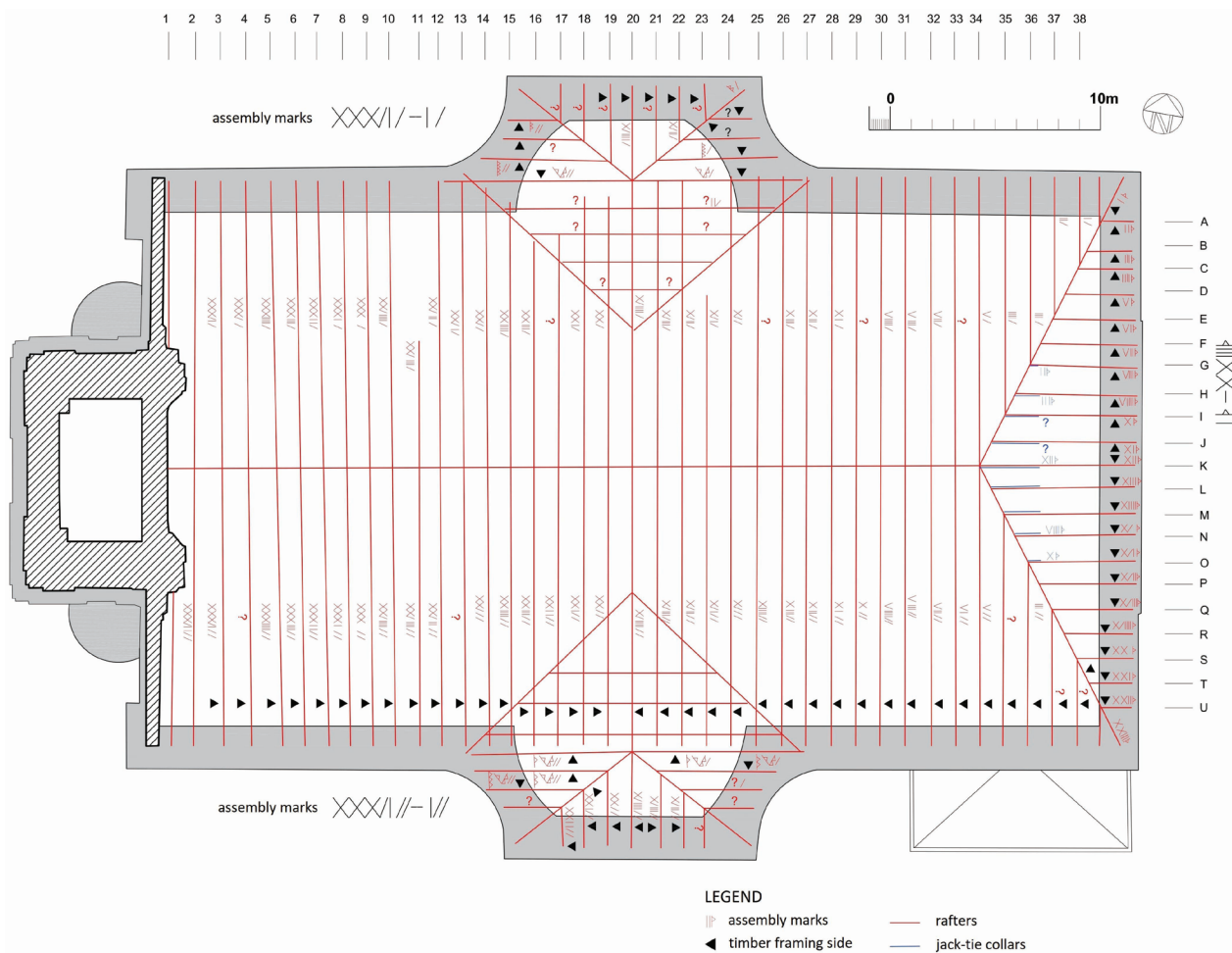

Fig. 3. Leszno, Church of the Holy Cross, roof structure, diagram, top view, arrangement of trusses and system of carpentry assembly marks (elaborated by U. Schaaf, M. Prarat)

II. 3. Leszno, kościół św. Krzyża, więźba dachowa, schemat, widok z góry, układ wiązarów i system ciesielskich znaków montażowych (oprac. U. Schaaf, M. Prarat)

short tie beams, which, in turn, also rest on double binding beams, also stretched between the pillars of the octagon.

The roof structure consists entirely of 38 trusses arranged in the transverse direction of the church and – within the three-sided closure from the east – of two corner trusses and 21 jack ties arranged in the longitudinal direction of the church, marked from A to U (Fig. 3). The solution of the rectangular roofing method in the projection of the body with an elongated, vaulted octagon inscribed in it required, not only the use of a complicated mixed structural system, but also a whole range of different types of roof trusses. Among them, five basic types should be distinguished, i.e., a principal rafter truss in two basic types, a paired common rafter, a corner truss, and a jack tie. Most of these types also come in different variants, which are briefly described below (Fig. 4).

The principal rafter trusses of the first variety are available in three variants. A typical truss (trusses: 10, 18, 22, 30) consists of the following elements: two short tie beams [17, p. 95] based either on walls/pillars or on double binding beams, two rafters, and one collar beam; on the lower tier, an inclined standing queen post and a straining beam between them, a pair of passing braces supporting the strain-

ing beam, a frame of two queen posts along the inner octagon (in trusses 5 to 34); on the upper tier, it is made of a king post supported by a pair of passing braces. The king post is additionally supported by passing braces and braces on both tiers, and the passing braces on the lower tier are connected with a short brace. The second variant (trusses: 14, 26) is devoid of king posts on the southern and northern sides of the inner elongated octagon. On the other hand, in the 5th and 34th principal rafter trusses, the queen post truss extends across both tiers. On the lower tier, it is additionally supported by a pair of passing braces based on an eaves purlin.

The second type of the principal rafter truss differs from the first type in that it is devoid of a hanging king post structure. It comes in two variants. In the first variant (trusses: 12, 16, 20, 24, 28, 32) it is composed of the following elements: two short tie beams supported on the lateral wall of the church on the outside, and, on the inside, on double binding beams between the pillars of the inner octagon, two rafters and one collar beam, an inclined standing queen post (without a straining beam), a pair of passing braces extending from the short tie beams to the collar beam with a straining beam between them, and a pair of braces stretched between the passing brace and

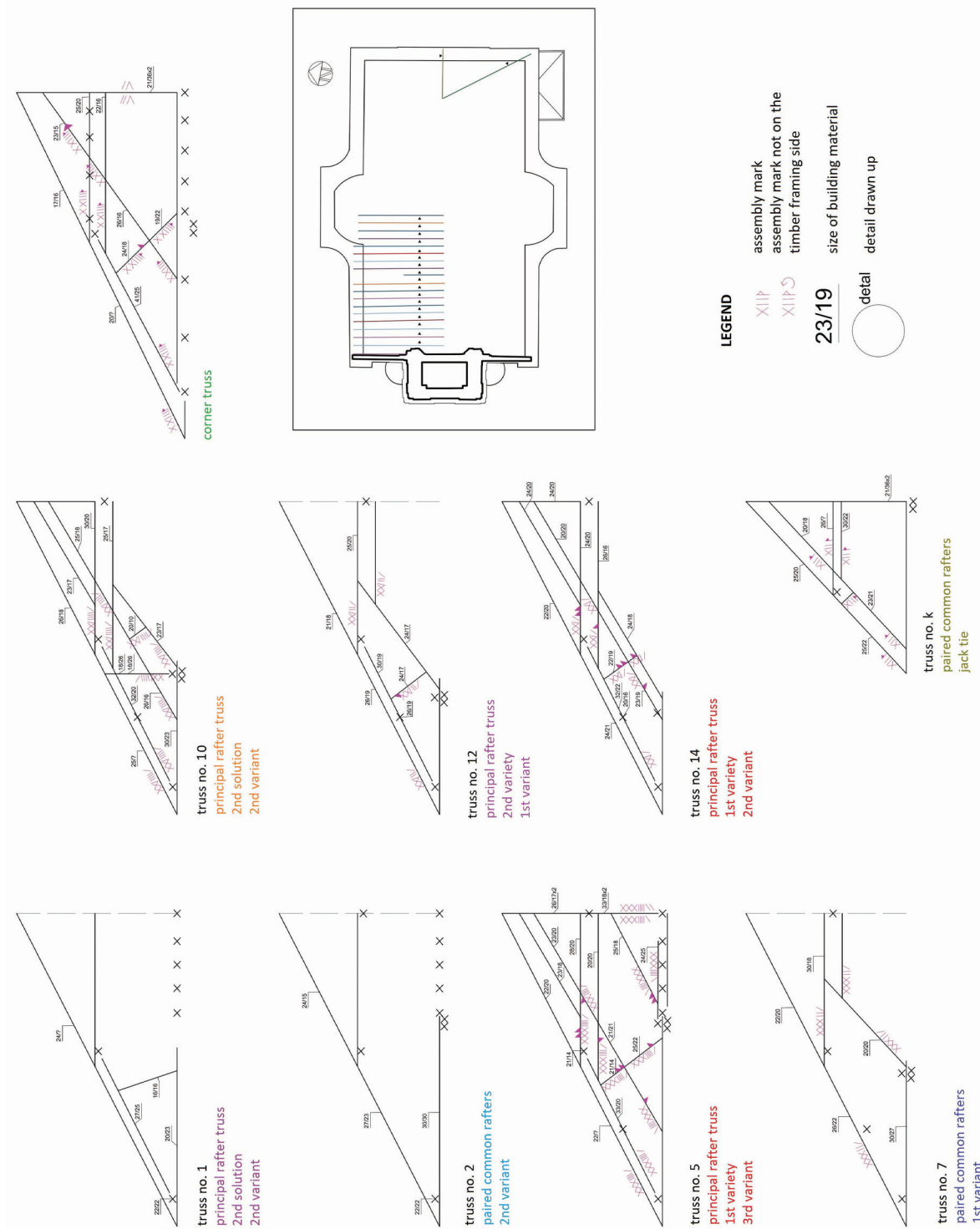

Fig. 4. Leszno, Church of the Holy Cross, roof structure, diagram, types of roof trusses (halves) (elaborated by U. Schaaf, M. Prarat)
 Il. 4. Leszno, kościół św. Krzyża, więźba dachowa, schemat, typy więźbar dachowych (połówki) (oprac. U. Schaaf, M. Prarat)

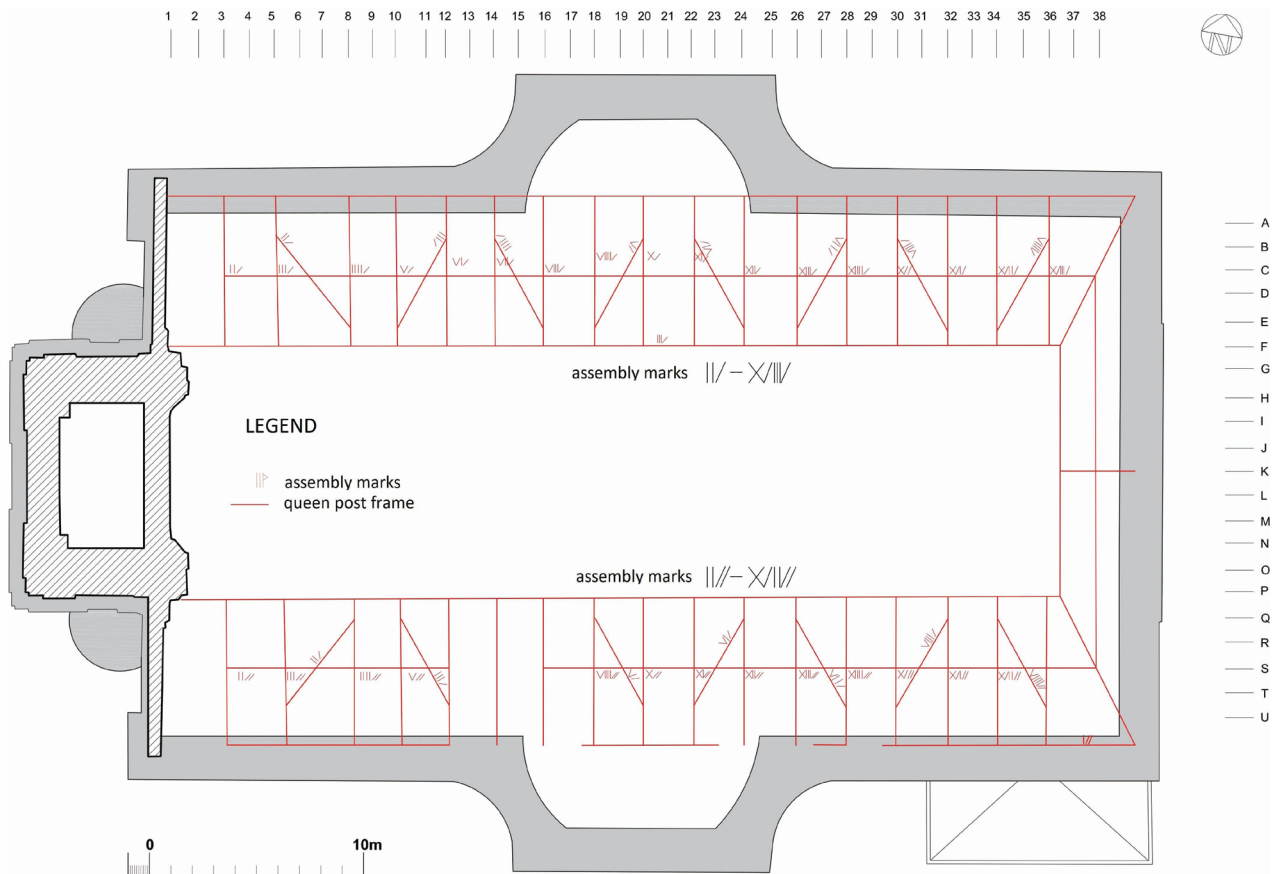

Fig. 5. Leszno, Church of the Holy Cross, roof structure, diagram, inclined standing queen-post frames (elaborated by U. Schaaf, M. Prarat)

Il. 5. Leszno, kościół św. Krzyża, więźba dachowa, schemat, ramy stolcowe (oprac. U. Schaaf, M. Prarat)

the inclined standing queen post. In the second variant (trusses 1, 3, 8), the truss is additionally devoid of a pair of braces and a straining beam. It consists of two short tie beams, two rafters and one collar beam, an inclined standing queen post (without a straining beam), and a pair of passing braces reaching from the short tie beams to the inclined standing queen posts.

The paired common rafter lacks both the hanging king post structure and an inclined standing king or queen structure. It also comes in two variants. In the first version (trusses: 7, 9, 11, 15, 17, 19, 21, 23, 27, 29, 31) it consists of short tie beams supported on the walls/binding beams, two rafters, one collar beam, a pair of passing braces extending from the short tie beams to the collar beam, and a straining beam between them. In the second version (trusses: 2, 4, 6, 13, 25, 33), the paired common rafter is devoid of a pair of passing braces and a straining beam, so it consists of only two short tie beams, a pair of rafters and one collar beam.

The corner truss consists of a rafter and a collar beam that connect to the queen post in truss 34, and the elements of the inclined standing queen-post structure, i.e., the inclined standing queen post itself, an eaves purlin and a straining beam, and two intersecting passing braces.

The jack tie comes in different variants. On the northern and southern sides (in trusses: 35–38), the jack tie consists of a short tie beam resting on a wall or a double binding beam and a jack rafter, which is connected with a cor-

ner rafter. In trusses 34–35, there are additional jack-rafter collars, which are connected to the collar beam of the corner truss above the hip purlin of the inclined standing queen-post frame. On the eastern side, the jack tie in the A–F and P–U trusses consists of a short joist reaching the short tie beam and a jack rafter connected to the corner rafter. On the other hand, in the G–O trusses, the jack ties consist of a short joist resting on the wall or on a double binding beam and located in the longitudinal direction of the church, a jack rafter, and a jack-rafter collar that connects to the collar beam in the corner truss.

In the longitudinal direction, one should distinguish between inclined standing queen-post frames and hanging king post frames. Horizontal inclined standing queen-post frames (Fig. 5) are essentially built of inclined standing queen posts in every other truss, placed on an eaves purlin lying on the trusses and coped with a hip purlin below the collar beams. Between the inclined standing queen posts, slightly below half the height of the frame, there is an additional string of spandrel beams. Inclined standing queen-post frames are additionally stiffened with passing braces stretched between the inclined standing queen posts in every other segment. In the eastern roof slope, the inclined standing queen post frame appears only in a reduced form. It consists of one inclined standing queen post in the central axis, resting directly on the short joist, coped with a hip purlin connecting with longitudinal inclined standing queen post frames within the corner rafters.

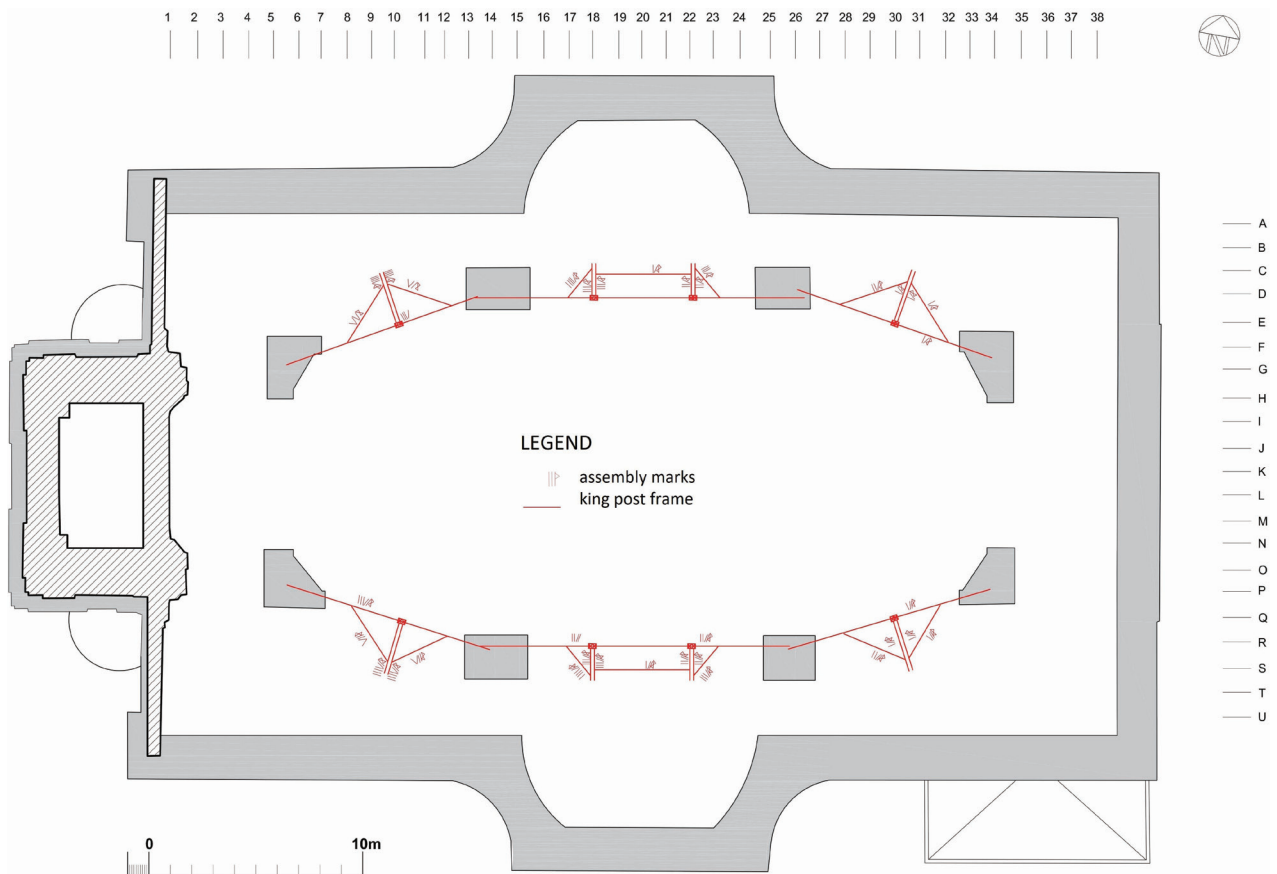

Fig. 6. Leszno, Church of the Holy Cross, roof structure, diagram, hanging king and queen post frames on the southern and northern sides of the elongated octagon (elaborated by U. Schaaf, M. Prarat)

Il. 6. Leszno, kościół św. Krzyża, więźba dachowa, schemat, ramy wieszarowe po stronie południowej i północnej wydłużonego ośmioboku (oprac. U. Schaaf, M. Prarat)

Standing king post or queen post frames on the lower tier (Fig. 6) run on the southern and northern sides along the inner, elongated octagon from truss 5 to truss 34. The tie beam of the hanging queen-post frames is based on pillars, and some short tie beams are suspended from it. The queen post itself, from which the stay is suspended, is present in trusses: 10–18, 22, and 30. In the hanging king post frames, each king post is supported by two passing braces. On the other hand, in the hanging queen-post frames, there is a straining beam between them instead of passing braces.

The hanging king-post frame on the upper tier (Fig. 7) is built of king posts found in trusses: 5, 10, 14, 18, 22, 26, 30, 34 and intersecting passing braces between them. Collar beams, a longitudinal spandrel beam, and straining beams are hung on the king posts. In trusses 5 and 34, queen posts extend through both tiers. A binding beam is suspended from the queen posts on which short tie beams rest.

The east-west beams on the western side are not directly related to the roof structure. On the western side, they rest on the wall of the tower, and on the eastern side, on a double binding beam (Fig. 8).

Carpentry joints

Various variants of lap, tenon, and cogged joints were used to build the roof structure. This was owing both to

their function and to the requirements of the assembly process (Figs. 9–11).

Double binding beams rest directly on the pillars or the western and eastern walls of the church. Both the short tie beams and jack rafters are embedded in the lateral walls on the outside. From the inside, the short tie beams connect with double binding beams at different levels using the middle notch (see Fig. 11, details H and J) or, in the case of an internal binding beam, also partially in the side notch. This joint secures the short tie beams in their location. The short joists are connected to the sections of the tie beams at one level by means of a pegged tenon joint with a straight bolt, which makes a greater load of this joint possible in the vertical direction (see Fig. 11, detail G).

The rafters are connected with short tie beams or jack rafters by a non-pegged tenon joint in three variants: without a notch, with a single front notch, or with a double notch (see Fig. 11, details I and J). It was not necessary to secure this connection with a peg, and the notch permits it to be loaded more with compressive force. In the ridge, the rafters are connected in principal rafter trusses of the first variety with king posts using a non-pegged tease tenon, with the end of the entire rafters partially recessed into a socket cut in a king post with a larger cross-section (see Fig. 9, detail D). This is how the king post was effectively suspended. In the remaining principal rafter trusses and

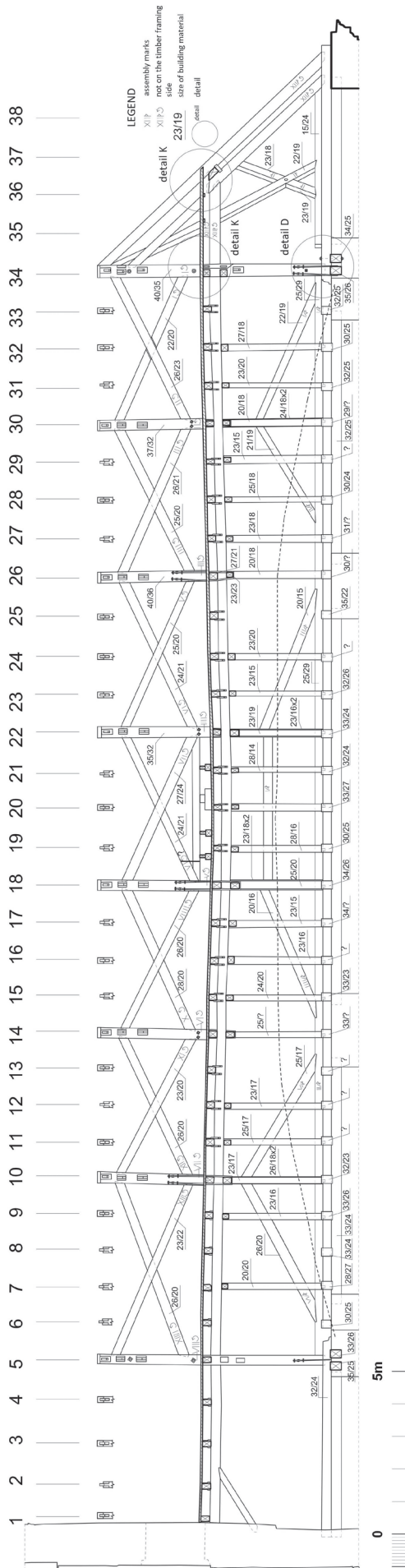

Fig. 7. Leszno, Church of the Holy Cross, roof structure, longitudinal cross-section (elaborated by U. Schaaf, M. Prarat)

II. 7. Leszno, kościół św. Krzyża, więźba dachowa, przekrój podłużny (oprac. U. Schaaf, M. Prarat)

paired common rafters, the rafters are connected with each other by means of a pegged scarf joint bridled with a full tenon (see Fig. 9, detail A) or a tease tenon. The last joint protects the tenon better against adverse weather conditions. Collar beams in these trusses connect to the rafters by a tenon with a front notch (see Fig. 10, detail L). The corner rafters are tenoned into diagonal short joists and connected to a queen post by means of a one-sided frontal angled notched joint. Jack rafters with diagonal cuts are butted to them.

In the inclined standing queen-post structure, eaves purlins are placed on the short tie beams by means of a central notch (see Fig. 9, detail C), while the inclined standing queen posts are tenoned both in the eaves purlin and in the roof purlin (see Fig. 10, detail L). The latter, in turn, connects with the collar beam by means of a side notch. The straining beam is connected to the inclined standing queen posts partially by means of a pegged tenon with a frontal angled notched joint, partially by a non-pegged tenon with a frontal angled notched joint (see Fig. 10, detail L) and partially only by a non-pegged tenon. The spandrel beams of the inclined standing queen-post frame connect to the inclined standing queen posts by a tenon, while the passing braces of the inclined standing queen-post frame connect to the roof inclined standing queen post by a frontal angled notched joint.

In the king post structure, the king post is present in trusses 10, 14, 18, 22 only within the upper tier. It is connected to the collar beam by a non-pegged tenon, and a longitudinal spandrel beam is suspended from it using a suitably bent flat bar, fastened with dogs and bolts (see Fig. 9, detail D). In the transverse direction, the king post is supported by passing braces, braces, and rafters. On the lower tier, each pair of passing braces extends from the short tie beams to the straining beam and connects to it by means of a pegged tenon with a frontal angled notched joint (see Fig. 9, detail E). In the extension of the passing braces, there is a pair of braces stretched between the straining beam and the collar beam; in order to connect these elements, a lap joint secured with a dog was used. The passing braces on the upper tier connect both with the collar beam and with the king post with a frontal angled notched joint. Owing to the larger cross-section of the king post, the ends of the passing brace are partially additionally embedded in the sockets cut in the king post (see Fig. 9, detail D).

The king post is – apart from two pairs of passing braces – additionally supported by rafters; their connection has already been described above. The intersecting passing braces of the longitudinal stiffener of the hanging king post structure are connected with king posts only by means of a frontal angled notched joint without a tenon, and with each other, by means of a simple lap joint (see Fig. 7).

In most of the principal rafter trusses and paired common rafters (exceptions are trusses: 2, 4, 6, 13, 25, 33) there is an additional pair of passing braces at the lower end, which connects at the lower end with sections of the tie beam and at the upper end, either with a straining beam or with a collar beam using a frontal angled notched joint (see Fig. 9, detail E). In the second case, the straining

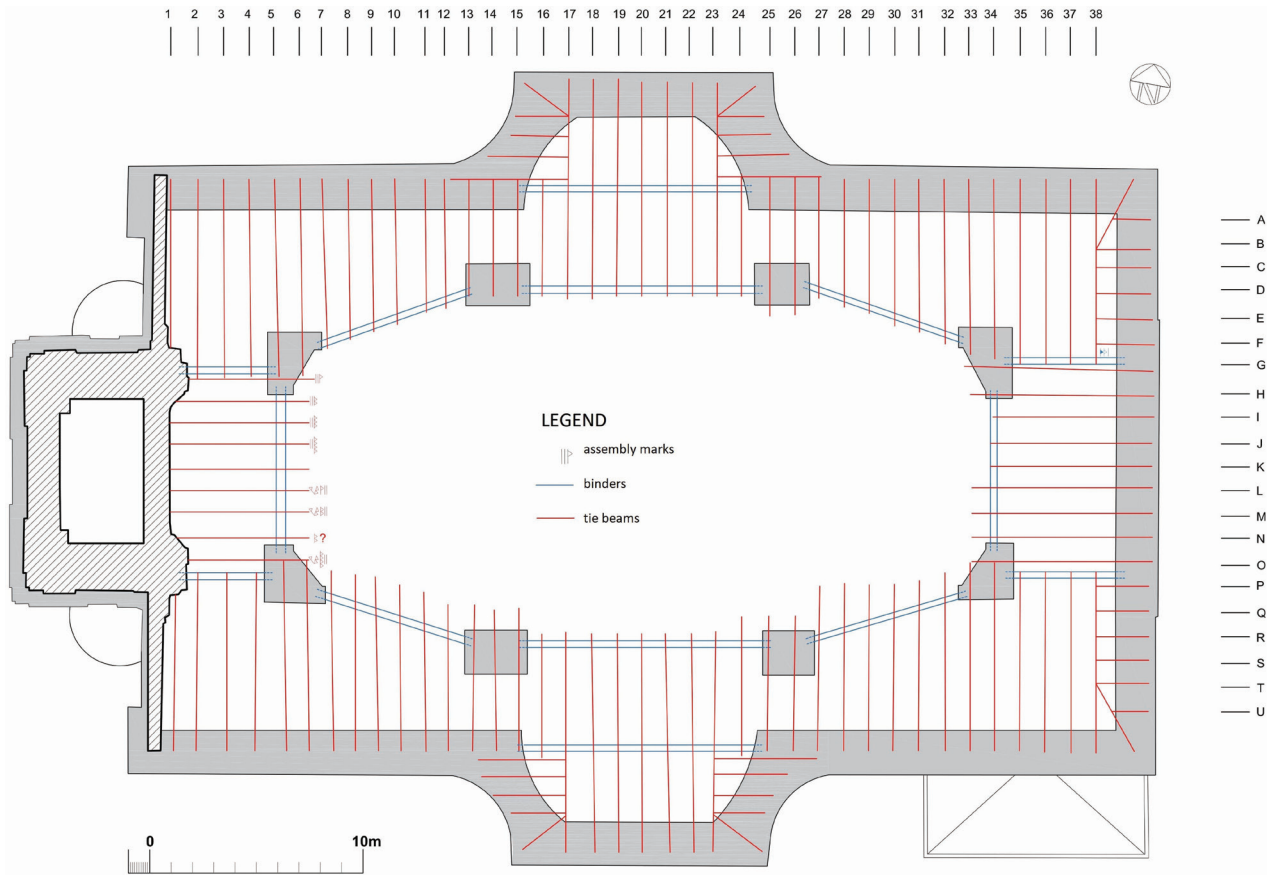

Fig. 8. Leszno, Church of the Holy Cross, roof structure, diagram, entablature diagram (elaborated by U. Schaaf, M. Prarat)

Il. 8. Leszno, kościół św. Krzyża, więźba dachowa, schemat belkowanie (oprac. U. Schaaf, M. Prarat)

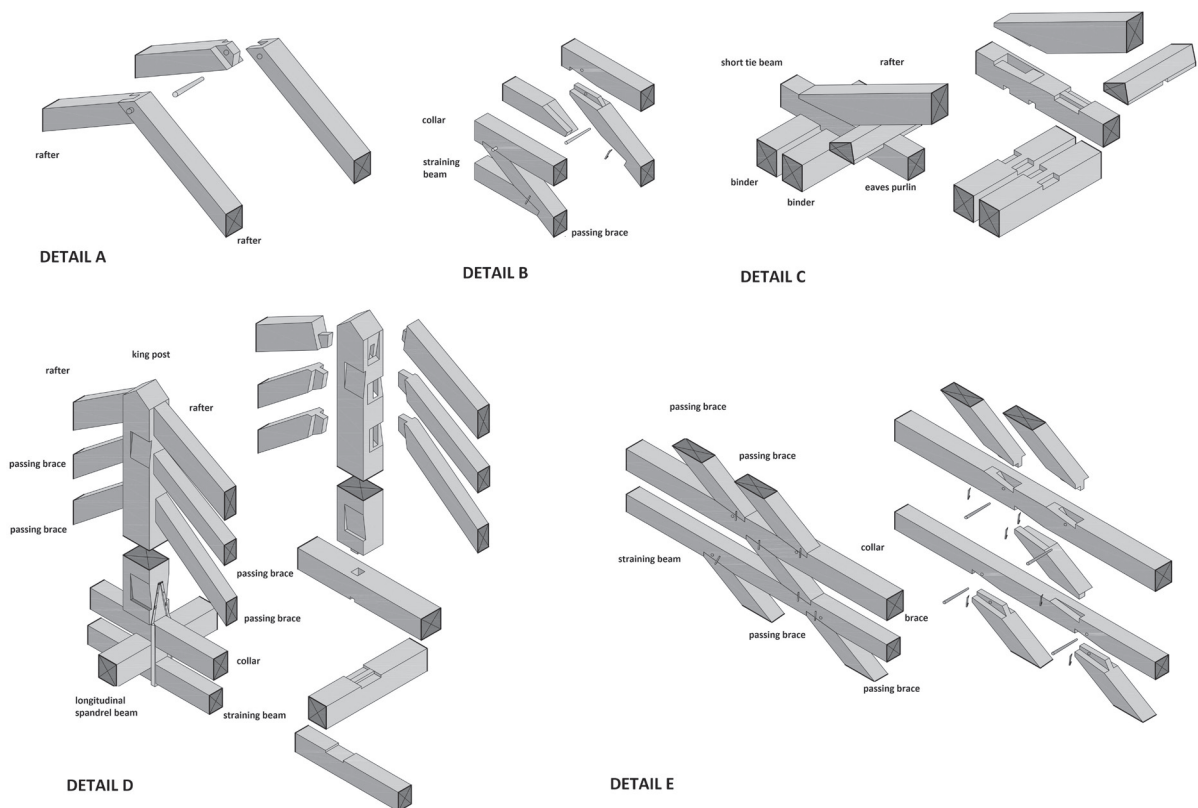

Fig. 9. Leszno, Church of the Holy Cross, roof structure, construction details (elaborated by U. Schaaf, M. Prarat)

Il. 9. Leszno, kościół św. Krzyża, więźba dachowa, detale konstrukcyjne (oprac. U. Schaaf, M. Prarat)

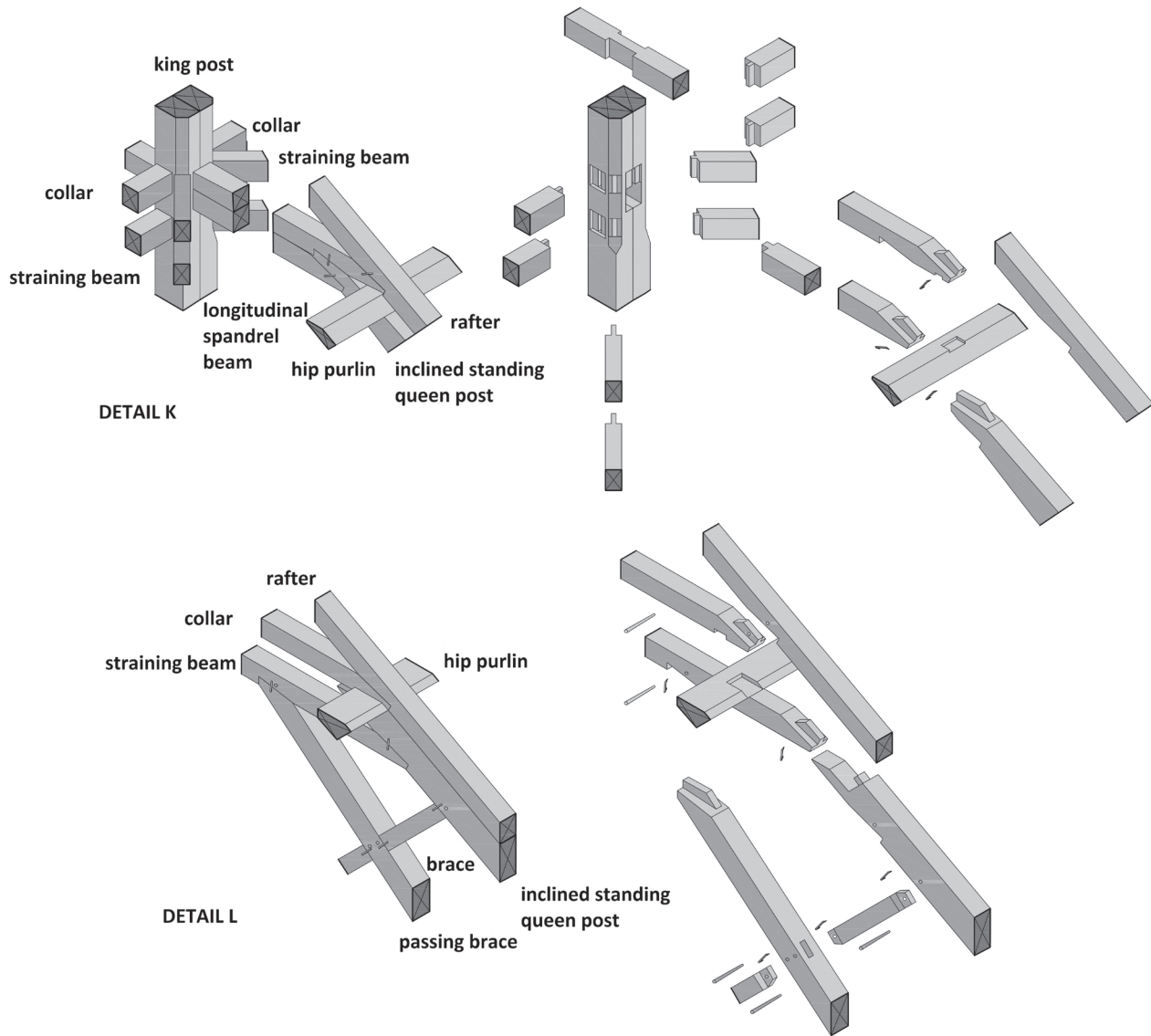

Fig. 10. Leszno, Church of the Holy Cross, roof structure, construction details (elaborated by U. Schaaf, M. Prarat)

Il. 10. Leszno, kościół św. Krzyża, więźba dachowa, detale konstrukcyjne (oprac. U. Schaaf, M. Prarat)

beam reaches only this passing brace. Both elements are connected by means of a lap joint secured with a dog. The braces, also present in the principal rafter trusses of the lower tier, connect both with the passing braces and with the hanging king post by means of a pegged tenon joint.

A hanging king post in trusses 5 and 34 extends across both tiers. On the lower tier, it connects to the short tie beam by means of a tenon. One of the double binding beams is suspended from the king post by means of two flat bars, bent appropriately and fastened with dogs and bolts. Two sections of the tie beam were connected with short tie beams by means of a notch, and a pair of supporting passing braces were connected to both the tie beam sections and the king post using the frontal angled notched joint. The transverse, longitudinal, and diagonal spandrel and collar beams above are connected to the king post essentially by means of a tenon (Fig. 11, detail F). For this purpose, the queen post was given an appropriate hexago-

nal shape. The joints used to suspend the queen post from the upper tier are essentially the same as those described above as regards the queen post covering only the upper tier.

In the hanging king or queen post structure, along the inner octagon, the tie beams connect with the short tie beam using the frontal angled notched joint (Fig. 11, detail H). Some of these joints are additionally held together with bolts. The hanging queen post itself extends from the tie beam in which it is tenoned into the inclined standing queen post with a lap joint on the side of each section of the hanging queen post. A tie beam is suspended from the hanging queen post by means of two appropriately bent flat bars attached with dogs and a bolt. The hanging queen post is in turn supported by a pair of passing braces which are connected to the tie beam using a frontal angled notched joint, and to the hanging queen post by means of a tenon with a frontal angled notched joint or only by a frontal angled notched joint.

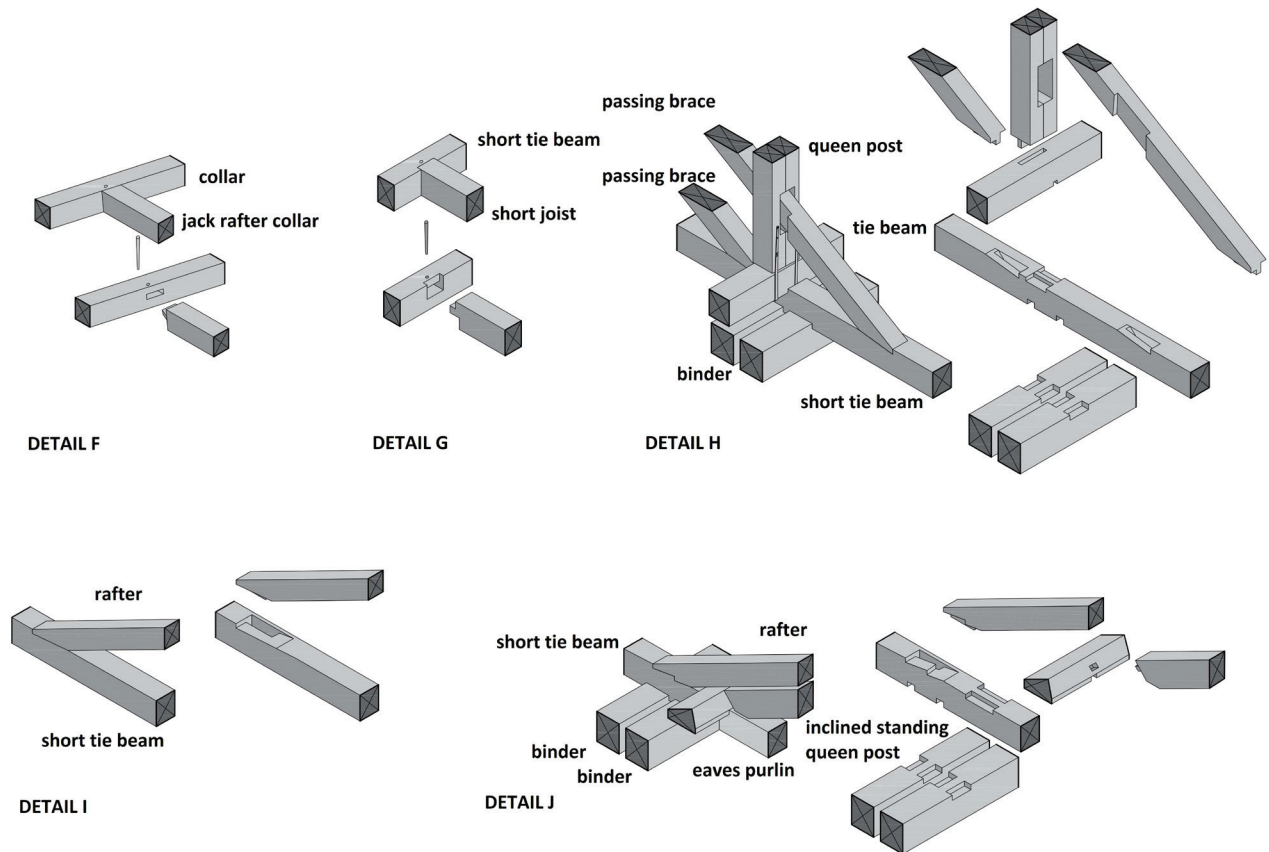

Fig. 11. Leszno, Church of the Holy Cross, roof structure, construction details (elaborated by U. Schaaf, M. Prarat)

Il. 11. Leszno, kościół św. Krzyża, więźba dachowa, detale konstrukcyjne (oprac. U. Schaaf, M. Prarat)

Building material and its processing

The cross-sections both between individual types of truss elements and within one type are very different. Regardless of the differences in the cross-section within one type of structural elements, it can be concluded, however, that the building material was divided into several groups. The thickest ones include eaves and hip purlins as well as king posts, the cross-section after processing is about 38–40/28–32 cm. The elements with a thick section include binding beams, short tie beams, jack rafters, and inclined standing queen posts: about 30–36/18–28 cm. The average cross-section is demonstrated by rafters, collar beams, passing braces, braces, and straining beams, as well as king posts above the avant-corps and tie beams of the hanging king or queen post structure along the internal octagon: about 17–30/13–26 cm. Elements with a small cross-section include, among other things, spandrel beams in inclined standing queen-post frames – approx. 18–21/15–17 cm.

During processing, efforts were made to obtain the largest possible cross-sections. This is evidenced by the changing cross-section within one element, mainly long rafters, as well as the fact that some of the rafters were left with partial wane.

An ax was used for the pre-treatment of the logs, as evidenced by the transverse cuts on the surface of the timber. An adze was used to smooth them, as evidenced by longi-

tudinal, slightly rounded cuts. In this way, beams with the cross-section of the entire tree were obtained. In the whole truss, only some elements are made of the whole tree, processed only with an ax and an adze, and in addition, they are not among the thickest cross-section elements. These exceptions include, for example, some passing braces in the hanging king post structure. On the other hand, most of the structural elements additionally bear traces of slightly oblique cuts resulting from sawing on one, two, or even three sides. Additionally, on the outer surface of some elements, machining with an ax and an adze sometimes turns into machining with a saw (Fig. 12), which shows that the saw was not always used only to divide the whole tree into a half-tree or a cross-tree, as was usually the case. It can be assumed that in this way, efforts were made to obtain as many additional logs and boards as possible, which were used to make the curved plank roof covering the interior of the church (Fig. 2).

Carpentry assembly marks

Basically, Roman numerals were used to mark the structural elements during the timber framing process made with an ax and marks with a triangular shape made with a chisel and partially connected with the system of Roman numerals. Additionally, three types of by-marks were used: in the shape of oblique cuts made with an ax, triangular cuts at the corners of the truss structure elements made with



Fig. 12. Leszno,
Church of the Holy Cross,
roof structure, traces of ax
and saw processing
(photo by U. Schaaf, M. Prarat)

Il. 12. Leszno, kościół św. Krzyża,
więźba dachowa, ślady obróbki
toporem i piłą
(fot. U. Schaaf, M. Prarat)



Fig. 13. Leszno,
Church of the Holy Cross,
roof structure, carpentry
assembly marks, Roman numeral
in conjunction with by-marks
in the form of diagonal cuts
and triangular cuts on the edges
(photo by U. Schaaf, M. Prarat)

Il. 13. Leszno, kościół św. Krzyża,
więźba dachowa, ciesielskie
znak montażowe, rzymski znak
liczbowy w połączeniu
z przyznakami w postaci
skośnych nacięć oraz trójkątnych
nacięć na krawędziach
(fot. U. Schaaf, M. Prarat)

a chisel (Fig. 13), and marks of a triangular shape adjacent to a thin line made with a chisel and a stylus.

From east to west, all the trusses (principal rafter trusses, paired common rafters, and jack trusses) are marked from 1 to 38 with Roman numerals (see Fig. 3). The timber framing from truss 1 to truss 19 is on the western side, and truss 20 to truss 38 are on the eastern side. In order to distinguish the structural elements on both sides of the axis of symmetry, all elements on the northern side received an additional mark in the form of one oblique incision, and on the southern side – in the form of two oblique incisions. The collar beams and straining beams are partially double-marked – each time with the same numerical mark, but with different markings on the northern and southern sides. By-marks in the form of triangular corner cuts were not always detectable owing to the partial leaving of the wane and the lack of full access to the

structural elements. However, they undoubtedly served to distinguish similarly shaped structural elements in accordance with their height position. Here is an example: in principal rafter trusses with an inclined standing king post and a hanging king post, the straining beam has one triangular corner cut, and the collar beams slightly above the straining beam have two triangular corner cuts. On the upper tier of the same tie beam, the lower pair of passing braces has two corner cuts at two corners, and the upper pair of passing braces has one corner cut at one corner. Also, braces stretched between the passing braces or the brace and the inclined standing queen post are marked at least partially with triangular corner cuts – one on the lower and two on the upper brace.

In the inclined standing queen-post frames, all the passing braces and spandrel beams from the outer/upper side, separately from the west to the east, are marked with



Fig. 14. Leszno, Church of the Holy Cross, roof structure, carpentry assembly marks on both sides of the timber framing (photo by U. Schaaf, M. Prarat)

Il. 14. Leszno, kościół św. Krzyża, więźba dachowa, ciesielskie znak montażowe na dwóch stronach odwiązywania (fot. U. Schaaf, M. Prarat)

Roman numerals: passing braces from 1 to 9 (see Fig. 5), and spandrel beams from 1 to 18. Here, too, the by-marks in the shape of oblique notches were used to distinguish the northern side (one oblique notch) from the southern side (two oblique notches).

In the longitudinal frame of the hanging king post structure, the king posts and passing braces are also marked on the northern side with separate Roman numerals, but from east to west: king posts from 1 to 8, and passing braces from 1 to 14, each time are without by-marks (see Fig. 7).

Two hanging king post frames extending from truss 5 to truss 34 along the inner octagon are marked on the inside of the church. Roman numerals mark separately the truss, hanging king posts, passing braces, and spandrel beams from the east to the west: trusses are marked with one to three, king posts with one to four, passing braces with one to six, and the spandrel beam with one. In the case of a hanging king post structure, each part is identified identically. In order to distinguish this king post structure from other structure systems, all its elements have one additional mark in the shape of two triangular cuts adjacent to a thin line. In addition, one more sign was used to distinguish the two king post frames from each other: all the elements of the northern frame have an additional sign in the form of one oblique notch, and all the elements of the southern frame in the form of two oblique notches.

The corner trusses and jack ties within the eastern roof slope have a common system of carpentry marks (see Fig. 3). Generally, it consists of marking elements with Roman numerals. The corner trusses are marked on the eastern side, trusses A–J on the southern side, and trusses K–U on the northern side. The north-east corner rafter has mark 1, the jack-rafters from north to south have marks 2 to 22, and the south-east corner rafters have mark 23. Rafter collar beams occur only in G–O trusses. They are marked separately, from north to south, from 2 to 10. An exception to this rule is the collar beam in the middle tie beam K, which bears the Roman numeral 12, like a jack

rafter. All the structural elements of the truss within the eastern roof slope have an additional by-mark in the form of one triangular notch adjacent to a thin line, which made it possible to distinguish them from the other trusses.

The entablature on the western side, which is not directly related to the truss structure, has a separate system of assembly marks (see Fig. 8). The individual beams are marked from north to south with triangular signs partially mixed with Roman signs from 1 to 9. All the beams have an additional mark – two oblique cuts.

Also, the doubled binding beams are marked with marks and by-marks. However, owing to the lack of access, it was not possible to recognize the entire system.

All the roof structure elements were marked on at least one side of the timber framing, and those that lay twice on the carpentry platform during framing (i.e. those that have two sides of the framing), partially even on each side of the framing (Fig. 14). In the case of queen posts, each of them is marked separately.

Conclusions

For the reconstruction of the roof structure after the church fire at the end of the 18th century, a mixed and complicated construction system was used, enabling, on the one hand, the vaulting of the internal, elongated octagon, and, on the other hand, covering the entire large body with one large roof. This system combines elements from several typical solutions such as curved plank, rafter, inclined standing queen post, hanging king post, straining beam, strut frame, and hanging and strutted frame structures.

The complicated plan of the church – an elongated octagon inscribed in the rectangle – in combination with the aforementioned mixed construction system resulted in the use of various types of trusses with different variations and variants. This, in turn, required the use of a system of carpentry assembly marks, which made it possible during as-

sembly not only to subordinate the elements to the individual tie beams but also, within each time beam, to the correct side and to the correct location in height. The advantage of hanging king post, straining beam, strut frame, and hanging and strutted frame systems is reflected in the use of cog and cog-and-tenon joints, making the removal of compressive forces possible. In addition to them, in these systems, there are various screws, straps, and rails with which various structural elements were suspended from the king posts.

Building materials with different cross-sections were

used, depending on the future function of the processed logs. The whole tree was processed with an ax and an adze. Half-trees and cross-trees (quarter-trees) were obtained by dividing the entire tree with a saw. The processing was done sparingly while trying to obtain logs and boards for the curved planks.

Translated by
Edward Maliszewski

References

- [1] Tajchman J., *Propozycja systematyki i uporządkowania terminologii ciesielskich konstrukcji dachowych występujących na terenie Polski od XIV do XX w.*, "Monument. Studia i Materiały Krajowego Ośrodka Badań i Dokumentacji Zabytków" 2005, nr 2, 7–36.
- [2] Schaaf U., Prarat M., *Badania architektoniczne więźby nad nawą środkową kościoła Świętojańskiego oraz ich znaczenie dla historii budowlanej świątyni i średniowiecznego warsztatu ciesielskiego w Toruniu*, [in:] K. Kluczajd (red.), *Kościół Świętojański w Toruniu – nowe rozpoznanie*, Stowarzyszenie Historyków Sztuki, Toruń 2015, 125–155.
- [3] Warchoła M., *Historyczne więźby dachowe kościołów w Warszawie*, Miasto Stołeczne Warszawa, Warszawa 2015.
- [4] Tajchman J., Iwanek A., *Więźba wieszarowa nad kościołem pw. św. Anny w Lubartowie*, "Biuletyn Historii Sztuki" 2018, t. 80, 633–652.
- [5] Kohte J., *Verzeichnis der Kunstdenkmäler der Provinz Posen*, Bd. 3, Verlag von Julius Springer, Berlin 1896.
- [6] Kohte J., *Bericht über die Denkmalpflege in der Provinz Posen*, 1. April 1907 – 31. März 1909, Arbeits- und Landarmenhaus in Bojanowo, Posen 1909.
- [7] Smend G., *Die Kreuzkirche in Lissa. Ein Beitrag zu ihrer Baugeschichte. Zur Erinnerung an die Errichtung des Turmhelms im Jahre 1909/10*, Eulitz Oskar, Lissa i. P. 1910.
- [8] Kręglewska-Foksowicz E., *Sztuka Leszna do początków XX wieku*, Wydawnictwo Poznańskie, Poznań 1982.
- [9] Kuztelski A., *Zbór ewangelicki św. Krzyża w Lesznie. Problem autorstwa i pierwotnego projektu*, "Kwartalnik Architektury i Urbanistyki" 1992, t. 37, z. 2, 145–157.
- [10] Harasimowicz J., *Leszno – Poznań – Warszawa. Protestantyczne budownictwo kościelne w osiemnastowiecznej Polsce i jego europejskie parantele*, [in:] T. Bernatowicz (red.), *Polska i Europa w dobie nowożytniej. Prace naukowe dedykowane Profesorowi Juliuszowi A. Chrościckiemu/ L'Europe moderne: nouveau monde, nouvelle civilisation?/ Modern Europe – New World, New Civilisation?*, Zamek Królewski, Warszawa 2009, 391–400.
- [11] Harasimowicz J., *Protestancka architektura kościelna XVI–XVIII wieku w Polsce i krajach sąsiednich*, "Rocznik Historii Sztuki" 2017, t. 42, 63–91.
- [12] Urban M., *Leszczyńskie zabytki protestanckie w dokumentacji konserwatorskiej*, [paper presented at the scientific conference entitled Reformation in Wschowa and the Greater Poland-Silesia border, Wschowa–Leszno, October 12–13, 2017, article in print].
- [13] Schaaf U., Prarat M., *Więźba dachowa pw. św. Krzyża w Lesznie z przełomu XVIII i XIX wieku. Dokumentacja z badań historyczno-architektonicznych*, Toruń 2018 [manuscript in: archives MKZ, Leszno].
- [14] Chudecka A., Wełniak P., Krzyżyński K., Przybyła R., *Inwentaryzacja budynku kościoła pw. św. Krzyża w Lesznie*, Poznań 2017 [manuscript in: archives MKZ, Leszno].
- [15] Wojewódzki Urząd Ochrony Zabytków w Poznaniu, *Kościół św. Krzyża* [building file (KŚWK)].
- [16] [n.a.], *Kościół pw. Świętego Krzyża w Lesznie*, <https://regionwielkopolska.pl/katalog-obiektow/kosciol-pw-swietego-krzyza-w-lesznie/> [accessed: 20.03.2022].
- [17] Raczyński, J., *Przyczynki do historii ciesielskich konstrukcji dachowych w Polsce*, "Studia do dziejów sztuki w Polsce" t. 3, Wydawnictwo Zakładu Architektury Polskiej Politechniki Warszawskiej, Warszawa 1930, 95–129.

Abstract

Carpentry craft at the turn of the 18th and 19th centuries. Case study: the roof structure of the Church of the Holy Cross in Leszno

In 1790, a fire consumed the upper part of the Church of the Holy Cross in Leszno, which was built in the years 1711–1715. The reconstruction of the roof structure and the vaults took place in 1798–1802. It was an extremely complicated task because it was a construction spread over a rectangular body measuring 24 × 44 m with an elongated, vaulted octagon inscribed in the body. The purpose of this text is to present this complex construction. The research method consisted in the analysis of the structural system and layout, carpentry joints, building materials, their processing, and the system of carpentry assembly marks. The architectural research carried out in conjunction with the study of sources and literature on the subject enabled the reconstruction of the building history from the end of the 18th century to the 2nd half of the 20th century, and the recovery of the originally used carpentry craft. The discussed structure is a free collar beam roof structure with a hanging king post structure lying on the lower tier and a king post truss structure on the upper one. The king post was additionally supported by passing braces and braces reaching through both tiers, and the straining beam was also strengthened by additional passing braces on the lower tier. These solutions are known from the hanging and strutted frame and strut frame structures. Moreover, short tie beams were suspended from the king post or queen post structure within the inner octagon. This complex structural system required the use of various types of roof trusses, from the principal rafter truss and paired common rafter to the corner and jack-tie rafter. They also come in different varieties and variants. The results of the research may become a contribution to a broader analysis of the carpentry craft at the turn of the 18th and 19th centuries.

Key words: Leszno, roof structure, architectural research, carpentry craft

Streszczenie

Sztuka ciesielska na przełomie XVIII i XIX w. Studium przypadku: więźba dachowa kościoła św. Krzyża w Lesznie

W 1790 r. pożar strawił górną część kościoła pw. św. Krzyża w Lesznie, który zbudowany został w latach 1711–1715. Odbudowa więźby dachowej i sklepień nastąpiła w latach 1798–1802. Było to niezwykle skomplikowane zadanie, albowiem była to konstrukcja rozłożona nad prostokątnym korpusem o wymiarach 24 × 44 m z wpisanym w nim wydłużonym przesklepionym oktagonem. Celem niniejszego tekstu jest przedstawienie tej skomplikowanej konstrukcji. Metoda badań polegała na analizie systemu i układu konstrukcyjnego, złącz ciesielskich, budulca i jego obróbki, systemu ciesielskich znaków montażowych. Badania architektoniczne wykonane w połączeniu ze studium źródeł i literatury przedmiotu pozwoliły na odtworzenie historii budowlanej od końca XVIII do 2. połowy XX w. oraz wydobyć pierwotnie zastosowanej sztuki ciesielskiej. Omawiana konstrukcja to wolna więźba jętkowa o stolcach leżących na dolnej kondygnacji i konstrukcja wieszarowa jednowieszakowa na górnej. Wieszak wsparto dodatkowo zastrzałami i mieczami sięgającymi przez obie kondygnacje, a rozpór także dodatkowymi zastrzałami na dolnej kondygnacji. Są to rozwiązania znane z konstrukcji rozporowo-wieszarowej i rozporowej. Ponadto podwieszono stopki do konstrukcji jedno- lub dwuwieszakowej w obrębie wewnętrznego oktagonu. Ten skomplikowany system konstrukcyjny wymagał użycia różnych rodzajów wiązarów dachowych, od pełnego i niepełnego do narożnego i kulawkowego. Występują one w dodatku w różnych odmianach i wariantach. Wyniki badań mogą się stać przyczynkiem do szerszych analiz sztuki ciesielskiej na przełomie XVIII i XIX w.

Słowa kluczowe: Leszno, więźba dachowa, badania architektoniczne, sztuka ciesielska

