

Received March 17, 2016; reviewed; accepted September 16, 2016

VIBRATION ANALYSIS OF ROTATING MACHINES FOR AN OPTIMAL PREVENTIVE MAINTENANCE

Mounia TALEB^{1,2*}, Rachid CHAIB³

¹ Department of Mining Engineering, University of Tébessa, Tébessa, Algeria

² Department of Mechanical Engineering University of Skikda

³ Laboratory of Transport Engineering and Environment, Mentouri University-Constantine, Algeria.

Abstract: Face to the development and competition to competitiveness, which drives the search for quality and above all; cost reduction, maintenance has become one of the strategic functions in the company. One of the solutions incorporated in management systems is Conditional maintenance that has proved successful; Reduce downtime, optimize manufacturing, ensure safety and profitability of production. For this type of maintenance to be effective, precise and reliable measurements are required. Experience has shown that vibration analysis is the most widely used technique for reliable monitoring and diagnosis. The objective of this work is the study carried out at the Elma Labiod cement plant, which has adopted continuous monitoring in the hope of an optimal approach to conditional maintenance. We use the analysis of global velocity and acceleration levels, spectral analysis and envelope analysis to detect defects and anticipate degradations that can affect a mechanism and determine the probable causes of these malfunctions.

In this context, the actual measurements were analyzed by vibratory indicator leading to detection of the weak points causing a malfunction on the machine (rolling bearings), therefore an optimization of the maintenance is realized by monitoring the degradation through on-line control system. The analysis of these vibrations let the possibility to detect and locate the defective components once the fixed corresponding threshold limit of vibration level has been reached.

Keywords: Surveillance, Cement, Vibration, Conditional Maintenance

* Corresponding authors: taleb_mounia@yahoo.fr (T. Mounia).

INTRODUCTION

The implementation of a policy of conditional maintenance of rotating machines by vibratory analysis is now widely practiced in factories all over the world (Vasselin and Combet 2015).

Many searchers have been interested in the field of maintenance and vibration. Eugène Désiré EFAGA proposes a general strategy for organization and management of maintenance based on experience feedback, which consists in representing a structure that integrates the duality of the study on organizational and technico-economic aspect, makes it easier for decision-makers to make the right decisions (Eugene, 2004).

B. Iung, E. Levrat propose an approach that uses “odds” algorithm, based on optimal stop theory. The objective is to select, from all the planned production stoppages, those which will be optimal, to develop a maintenance tasks keeping the predicted product conditions (Iung and Levrat, 2007).

In his thesis D. Claire Breneur studied the case of combined gear and bearing defects by experiments applied to a gear unit model, he showed that the spectrum and the cepstrum of the acceleration signal envelope are a performant indicators (Breneur, 2002).

In a study carried out in Turkish ,authors have shown that vibrational analysis presents much advantage as a predictive technique of maintenance. They have diagnosed an external ring defect of a ball bearing (Orhan and al,2006).

In NF EN 13306 standard maintenance is defined as: “the assembly Of all administrative and management technical actions during the life cycle of an asset, intended to maintain or restore it in a state which in, it can perform a required function” (Duchemin, 2006).

In a manufacturing process, a often strategic role is played by Rotating machines, like a press in a paper mill or a turbine in a power plant, they are part of this equipment that can not be Not be able to stop at any time (Zani, 2003).

It is not enough to be concerned with the consequences of a malfunction but also with its cause which can be internal or external. Starting from an observation of an abnormal noise in the draft fan of the raw mill of the Tébessa cement plant, signaling an imminent dysfunction, we used vibratory analysis to highlight the problem of the equipment. The latter has experienced a lot of damage at the level of the reducer: the excessive increase in the overall level of the speed, exceeding the danger threshold, which indicated the existence of a defect of fixing, loosening Bolts, bearing wear etc. Several defects can be encountered on this equipment which can carry other damage to the whole technological chain such as unbalance, misalignment, wear of gears, play, cracks, lubrication problems. It must be installed in cement plants because of the nature of the finished product.

To make a good diagnosis, monitoring equipment is set up. The concept of monitoring is based on changing the signature of the vibration. In this context, two forms of preventive maintenance are distinguished, namely conditional maintenance and predictive maintenance. Therefore, monitoring a machine requires selecting a certain number of indicators, measuring them either continuously (on-line monitoring) or periodically (off-line monitoring) and monitoring their progress in the time. Any significant change in the value of an indicator must lead immediately to the application of an adapted procedure (validation of the evolution, identification of the anomaly and its seriousness, scheduling of corrective actions, emergency stop, Exploitation in degraded mode, etc.) (Boulenger and Pachaud, 2003).

Generally, vibration sensors such as accelerometers are used for vibration monitoring. The measured parameters are displacement, velocity and acceleration (Bertrand, 2000).

CASE STUDY

In this study we are interested in the fan of the raw zone of the Elma Labiod cement production line located 35 km from the town of Tebessa located in the east of Algeria (Figure 1).

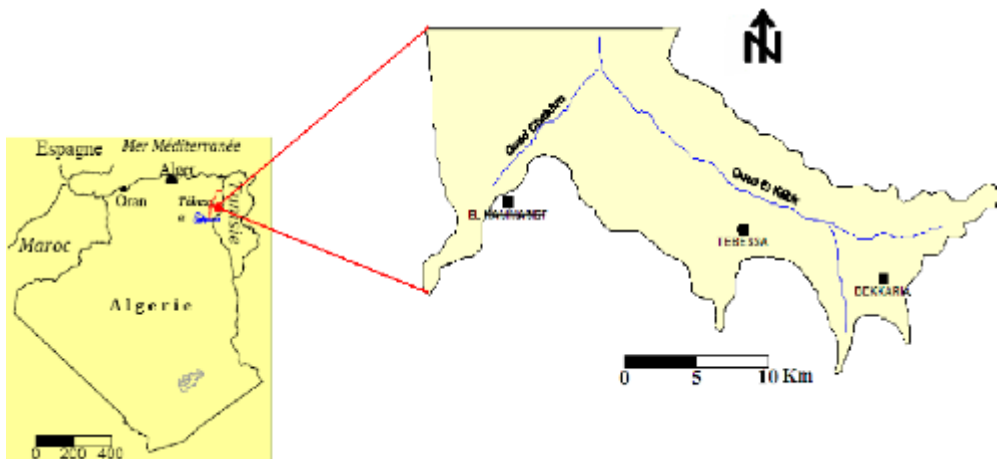

Fig. 1. Geographical location of the Elmalabiod cement plant in Tébessa

Following an abnormal noise reported by employees, and in order to anticipate the degradation that may affect a mechanism, detect defects at a more or less early stage, avoid very expensive production stoppages due to unforeseen failures, Diagnosis was carried out using vibratory analysis (spectral analysis, measurements of global vibrational levels in speed, acceleration and envelope analysis). The application

of this approach allowed us, after analysis, to estimate the risks of failure. Particular attention is paid to fan reducer, which represents one of the links forming the cement production line, from limestone extraction to cement shipping (Figure 2).

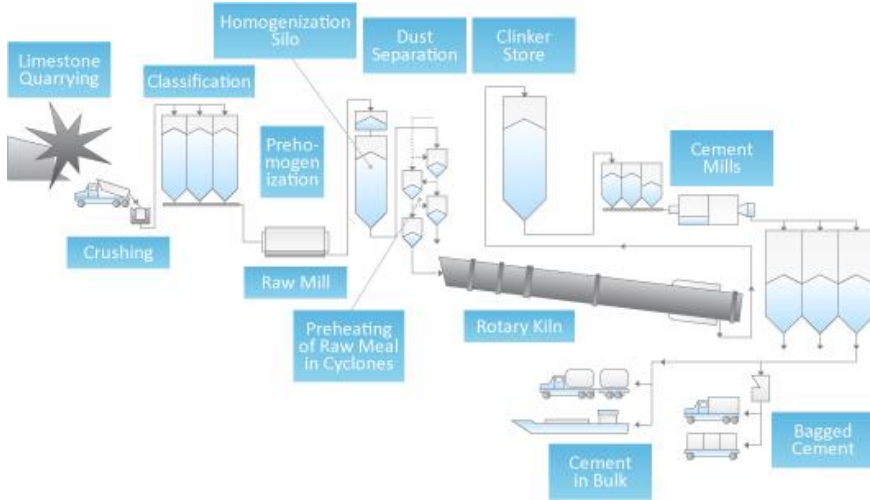

Fig .2 . The cement manufacturing process (www.westchinacement.com)

As mentioned above, this work consists of the monitoring of a fan control equipment RIS07 of the raw zone of the Elmalabiod cement plant (Figure 3) consisting essentially of a motor, a reducer and a ventilator.



Fig. 3. a) Fan control equipment, b) a sensor control point near the Fan

MATERIALS AND METHODS

In this work, we are interested in monitoring rotating machinery while using vibration analysis. This maintenance mode in machinery vibration analysis can better manage failures, detecting defects at an early stage, before they become critical (Bertrand, 2000).

Machine monitoring is not limited just to detect the presence of a defect, but it is also necessary to be able to make a thorough diagnosis to locate precisely and quantify its severity. Vibration analysis is a technique that allows this diagnosis (Knight, 2001). For clarification, diagnosis by vibration analysis requires to study: the values of the overall level of vibrations, the frequency content of signals using signal processing sophisticated tools (spectrum, cepstrum, envelope analysis etc.) (Djebili, 2013).

Note that the main technical data are required for classification of the equipment, and determining the alarm thresholds for the establishment of the vibration signature fan (Belhour, 2008).

The vibration analysis equipment used in this study are:

- An analyzer collector: Portable called “movilog2” which presents a very advanced synthesis of research, especially in computer science and advanced electronics. This type of hardware has great performance thanks to its connection to a computer equipped with software called “Diva”(Figure 4).

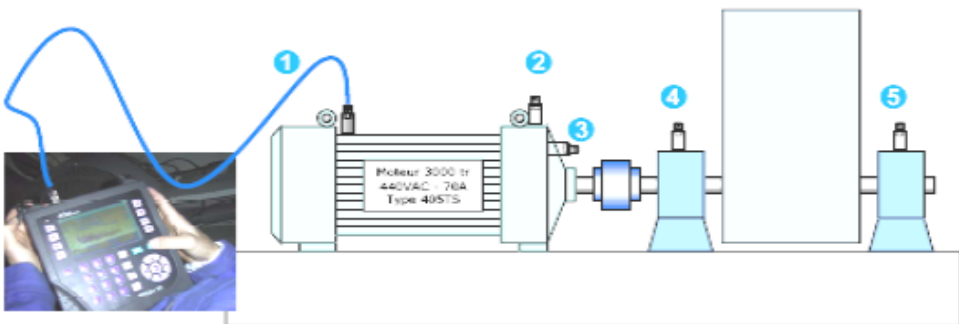

Fig. 4. Continuous monitoring (Belhour,2008)

- An Accelerometer: They are sensors used to ensure the vibration readings of a various measuring points.

- A Vibration Analysis Software DIVA: This software is designed especially for conditional and predictive maintenance, for the processing of the signals emitted by different types of vibrations.

After a tour round, we found that the problem lies in reducing levels of raw fan of the cement chain of production, cement plant Elmalabiod Tebessa. For lack of compe-

tence and surveillance equipment, the maintenance department in collaboration with a specialized maintenance company found it useful to adopt a monitoring equipment. We configured eight measuring points to detect weaknesses generating when there is a machine malfunction (Figure 5).

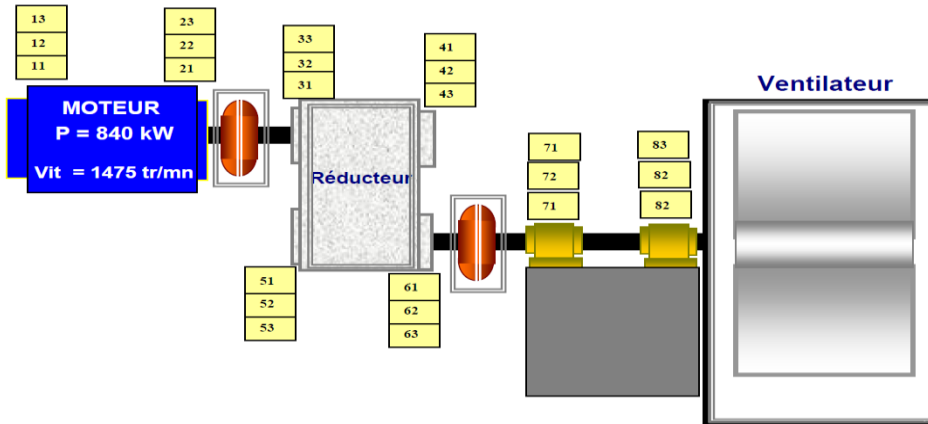

Fig. 5. Block diagram of the fan dispositive

RESULTS AND DISCUSSION

MOTOR AND REDUCER

On the motor and the gearbox the measurements have shown that the overall vibratory levels readings for acceleration and speed and bearing failure are acceptable. We go to the bearings of the fan or the problem seems more interesting and requires careful interest.

THE FAN BEARINGS

The measurements carried out in 2012 on these items are shown in Fig. 6 and 7.

The first measure discern an elevated readings levels overall acceleration on the bearings. However, the speed readings overall vibration levels are acceptable, and the failure factor tolerable ride.

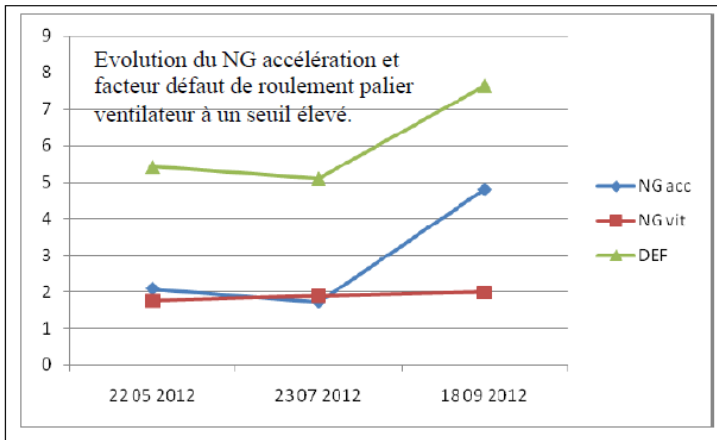

Fig. 6. Curve trend in overall levels developed 8RH (1st degree)

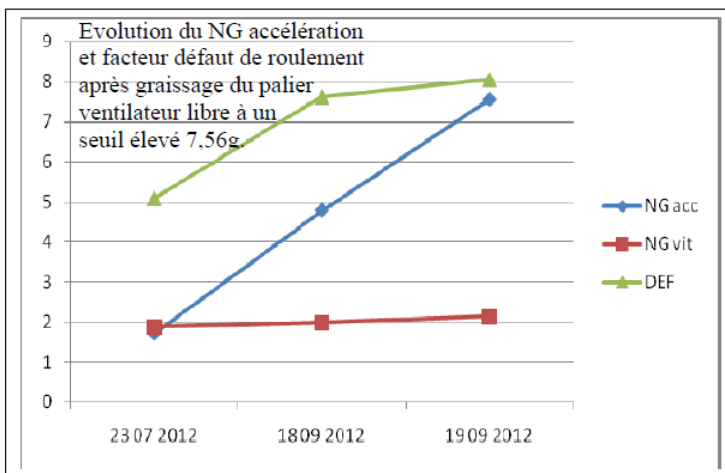

Fig.7. Curve trend in overall levels developed 8RH (2nd degree)

The second measurement highlight the evolution of the NG acceleration and the default factor to a high threshold 7.56 g – 8.05def.. To better understand the phenomenon and have more information about the malfunction, we went to the spectral analysis fig. 8.

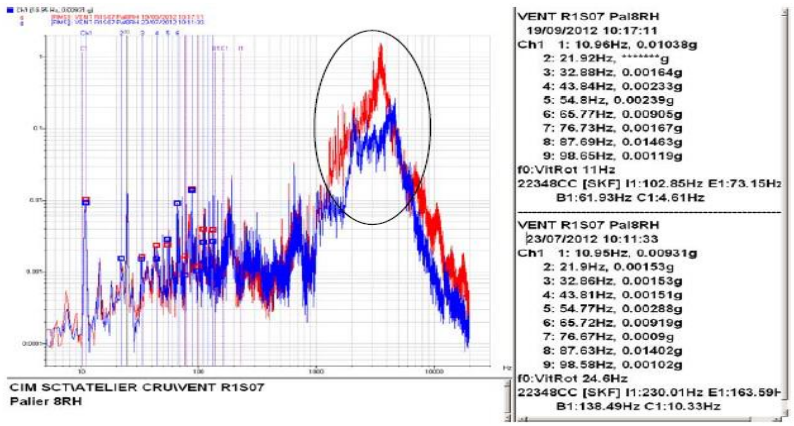

Fig. 8. Spectral analysis in September 2012

The spectral analysis show the existence of an unbalanced fan of 0.01 g to 10.96 Hz. This is stable and acceptable with an evolution of energy at high frequencies (defective bearing). Then for more details on the behavior of these elements, we appealed to the envelope analysis, Fig. 9.

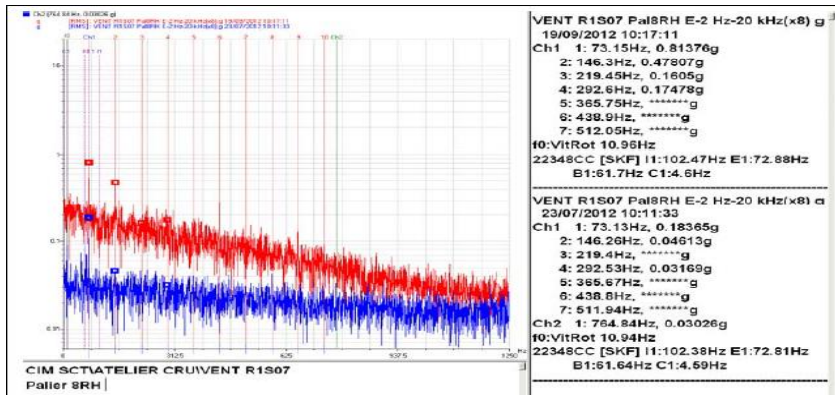

Fig. 9. Envelope Analysis September 2012

GLOBAL ANALYSIS

In 2013 further steps were performed on the same fan control equipment precisely levels or was revealed the results shown in the figures 10, 11, 12 and 13.

Overall analysis showed a change in the overall vibration levels recorded in acceleration axially to a tolerable threshold. As against the overall vibration levels recorded in speed and bearing failure factor remained stable at a qualifying threshold figure 10.

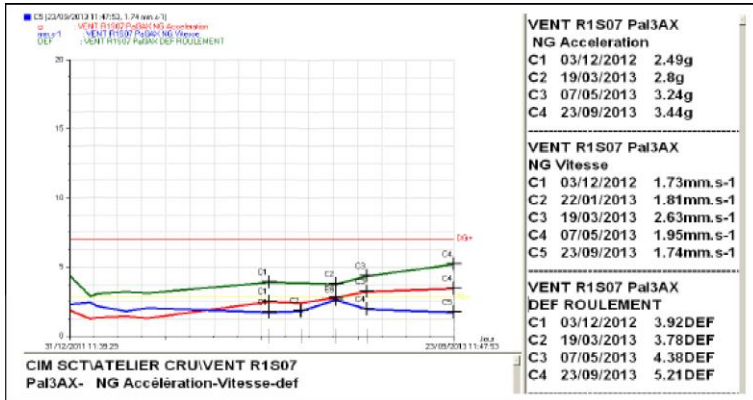

Fig. 10. Curve NG trend of acceleration, speed and def to entry

SPECTRAL ANALYSIS

This analysis revealed high amplitude to the 3rd harmonic of the meshing frequency 2.43g 3x 64.6 HZ, sidebands (modulation) around the meshing frequency spaced by the frequency rotation of the PV output shaft and input 10.93Hz GV 24,99Hz, and changing amplitudes of the first harmonics of the rotational frequency GV Fig. 11.

According to our results, we note the existence of several harmonics which are indicative of defects inducing shocks such forces, such as games or chipping on surfaces of a bearing or the teeth of a gear. The number of these harmonics depends on the "brutality" of the shock, so its brevity (Boulenger, 2006).

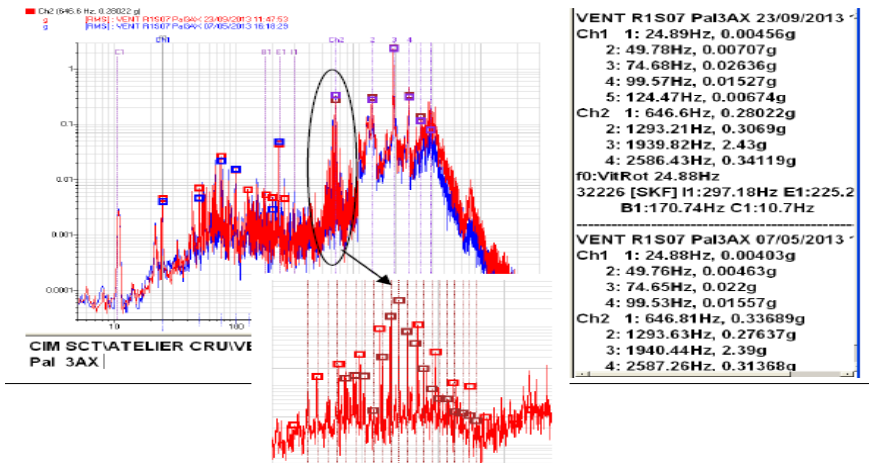

Fig. 11. Spectral Analysis September 2013

FAN BEARINGS

The overall analysis of these elements show the stability of the overall vibration levels recorded acceleration and speed with a default factor tolerable bearing, Fig 12.

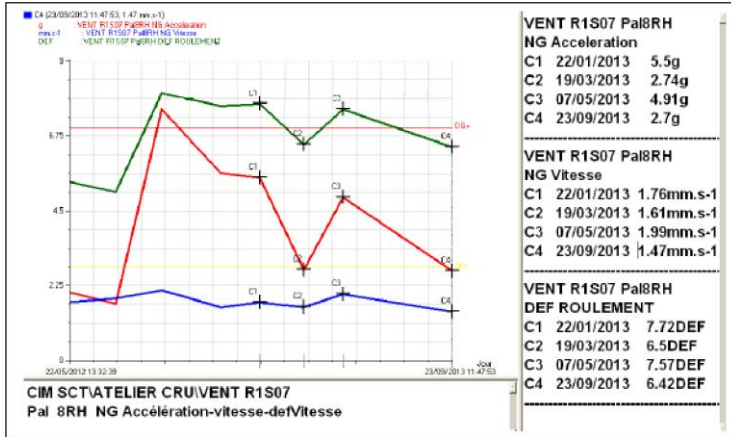

Fig. 12. Curve trend of accelerating loose bearing NG

SPECTRAL ANALYSIS

This analysis showed an imbalance acceptable fan 0.007 g 11 to 11 HZ.

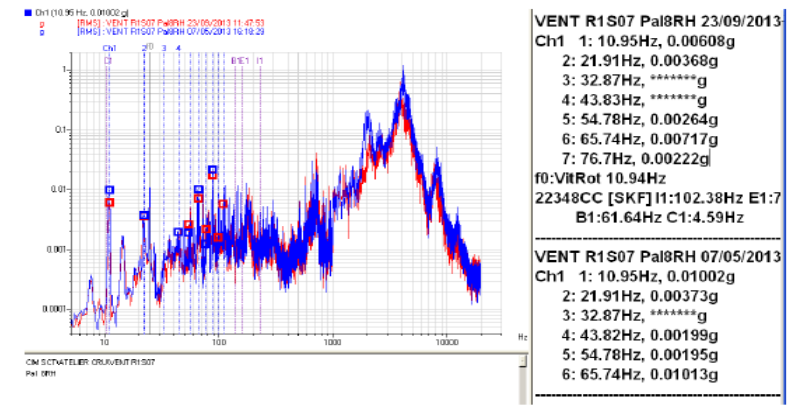

Fig. 13. Spectral analysis of floating bearing

The almost-time intervention prevented the gear unit from deteriorating due to the failure of the rolling bearings, which would have caused the fan of the raw zone to

stop, with serious economic consequences related to: Production, estimated at 1200 t / d (1 billion centimes).

CONCLUSION RECOMMENDATIONS AND OUTLOOK PERSPECTIVES

Technical and industrial mastery of the production facilities based in particular on the current maintenance of equipment and systems, and exceptional service that is related to the end of their technical life. In its most general sense, maintenance is not restricted to the corrective actions on equipment, such as repair or replacement, but it aims to ensure that the machines are constantly able to fulfill the function expected from them, in good conditions of security and profitability. These actions include inspections of fundamental equipment for a diagnosis on the state of the latter. Thus, it is necessary that industry shall ensure that the operators of facilities and strategic machinery (on the economic and safety plan) implement policies adapted to the maintenance of safety and security issues, including a focus on quality and competitiveness. Now, in practice, facilities get older and market competitiveness becomes a key concern of manufacturers. Therefore, it is essential that maintenance remains appropriate to the important role it must play in preventing incidents and unplanned outages: detect and correct defects before they endanger the facilities health or production and security in business. Vibration analysis allows for files to know the past evolution of the state of the machine and safe procedure to predict dates, intervening just before the failure occurs and make the replacement wisely. By that mean we can improve machines tasks and get them to a level often exceeding the origin specifications. Thus, the maintenance phase should ideally be reduced to operations of replacing, without trial and error, the actual equipment down and make selective service: "The vibration signal is the identity of the machine."

To address the problem, we recommend rinsing and replacement grease free bearing (fan side). At the end of this work we recommend the following actions:

- Inspection of the state of the gears;
- Verification of the process (adjustment of the valves);
- Program the alignment of the chain.

ACKNOWLEDGEMENTS

The work presented was conducted in the doctoral thesis framework, among other we thank all those who contributed to the realization of this study

BIBLIOGRAPHY

- BELHOUR S., 2008. *Contribution to optimizing predictive maintenance By using the software OM-NITREND (on line system) Case: Cement Hamma bouziane*. doctoral thesis in mechanical sciences, University of Constantine, Algeria, 90.
- BERTRAND R., 2000. *Detection and localization of failures on an electrical drive* doctoral thesis in electrical energy. National Polytechnic Institute of Grenoble - INPG.
- BOULENGER A., 2006, *predictive maintenance by vibration analysis, Engineering Technique*. MT 9 285,77-84.
- BOULENGER.A, PACHAUD C, 2003. *Maintenance vibration analysis: monitoring and diagnostics of industrial management series machines*, Dunod, Paris.
- BRENEUR C., 2002. *Elements of preventive maintenance of rotating machines in the case of combined defects of gears and bearings, doctoral thesis, doctoral school of sciences for the engineer of lyon*.
- CHAIB R., 2009. *Contribution to the optimization of predictive maintenance by vibratory analysis*, doctoral thesis in mechanical sciences, University of Constantine, Algeria.
- DJEBILI O., 2013. *Contribution to the predictive maintenance by vibration analysis of rotating mechanical components*. Application to ball bearings subject to rolling contact fatigue, University of Reims Champagne-Ardenne.
- DUCHEMIN G., 2006. Engineering technology BM 4 188, *Maintenance of machinery and engines*.
- EUGENE D., EFAGA, 2004. *Analysis of feedback data for the organization of maintenance of SME / SMI equipment in the framework of the MBF (reliability-based maintenance), doctoral thesis, ULP-UY I N° :LEPSI-EA 3118*.
- IUNG B., LEVRAT E.,THOMAS E., 2007. *Odds Algorithm'-based Opportunistic Maintenance Task Execution for Preserving Product Conditions*, Annals of the CIRP vol. 56/1.
- KNIGHT R., 2001. *"State of the art monitoring and diagnosis of rotating equipment to EDF" RFM*.
- MARIE-LINE ZANI 2003. *Mechanical measurements monitoring of rotating machinery buying guide*, 77-84.
- ORHAN S., NIZAMI A., VELI C., 2006. *Vibration Monitoring for Defect Diagnosis of Rolling element bearings as a predictive maintenance tool: Comprehensive case studies*, NDT&E International 39, 293–298.
- OULMANE A., 2014. *Monitoring and fault diagnosis of rotating machinery in the field using time-frequency neural networks and fuzzy logic*, doctoral thesis in Mechanical Engineering University of Montreal.
- VASSELIN J.L., COMBET F., 2015. *Contribution of collecting raw time signals for vibration monitoring of a single production site, feedback*, 22nd French Congress of Mechanics.
- ZANI M. L., 2003. *Mechanical measurements monitoring of rotating machinery buying guide*, pp 77-84. <http://www.westchinacement.com/> Group structure & MANAGEMENT TEAM consulté le 14 /03/2017.