

Effect of a laser beam focus position on ion emission from plasmas produced by picosecond and sub-nanosecond laser pulses from solid targets

EUGENIUSZ WORYNA, JAN BADZIAK, JÓZEF MAKOWSKI, PIOTR PARYS, JERZY WOŁOWSKI

Institute of Plasma Physics and Laser Microfusion, ul. Hery 32, , P.O. Box 49, 00-908 Warszawa, Poland.

JOSEF KRÁSA, LEOŠ LÁSKA, KAREL ROHLENA

Institute of Physics, Academy of Sciences of the Czech Republic, Na Slovance 2, 182 21 Prague, Czech Republic.

ALEXANDER B. VANKOV

Research Institute for Laser Physics, St.-Petersburg, Russia.

The dependences of parameters of laser-produced ion fluxes on the laser focus position with respect to the target surface for picosecond laser pulses are presented and compared with the ones for sub-nanosecond pulses at nearly the same densities of laser energy. The experiments were performed with the use of chirped-pulse-amplification Nd:glass laser system. Thick Au targets were irradiated by normally incident laser pulses. The maximum intensities of the focused laser beams were 8×10^{16} and 2×10^{14} W/cm² for ps and sub-ns laser pulses, respectively. The particle fluxes were analysed with the use of ion collectors and an electrostatic ion-energy analyser. The ion current densities and the charges carried by ions as well as the maximum and peak velocities of fast and thermal ion groups as a function of the focus position for ps and sub-ns pulses were determined.

1. Introduction

Detailed investigations of plasma characteristics produced by focusing intense laser pulses onto solid targets, and particularly, of the characteristics of ion emission are stimulated by a broad variety of potential applications (*e.g.*, laser ion sources for heavy ion accelerators [1], [2] or direct ion implantation [3], [4]). The knowledge of ion emission characteristics may also help to explain some aspects of plasma expansion and the physical processes occurring in the plasma (in relation to laser absorption, mechanisms of particle acceleration, recombination processes, plasma instabilities, *etc.*) [5].

The investigations of ion emission from laser-produced plasma have been carried on for years with the use of nano- and sub-nanosecond [6]–[8] laser pulses as well as pico- and sub-picosecond [9]–[12] ones. The long-pulse and short-pulse

experiments have been done, however, in substantially different experimental conditions which causes difficulties in comparing the results of the experiments. Two comparative experiments on the ion emission from the laser plasma produced with laser pulses of considerably different duration, *i.e.*, 1.2 ps and 0.5 ns, were recently performed at the Institute of Plasma Physics and Laser Microfusion in Warsaw. This brief report presents the experimental results of the investigation of the dependences of some ion emission characteristics on the laser focus position with respect to the target surface. To our knowledge, they are the first observation of differences in the ion emission from the picosecond and sub-nanosecond laser-produced plasmas accomplished under the similar experimental conditions.

2. Experimental set-up

The experiments (Fig. 1) were performed with the use of terawatt Nd:glass chirped-pulse-amplification (CPA) laser system [13]. The laser can deliver up to 1 J in 1.2 ps single pulse at a wavelength of 1.054 μm with a long-time scale contrast ratio higher than 10^8 . The laser beam was focused with the use of parabolic mirror (27 cm focal length) onto Au foil targets with a thickness of 40 μm at an angle of 0° with respect to the target normal. The hole in the centre of the mirror made measurements of the plasma streams expanding normally to the target surface (along the laser beam axis) possible. The maximum intensity of the focused laser beam was up to $8 \times 10^{16} \text{ W/cm}^2$.

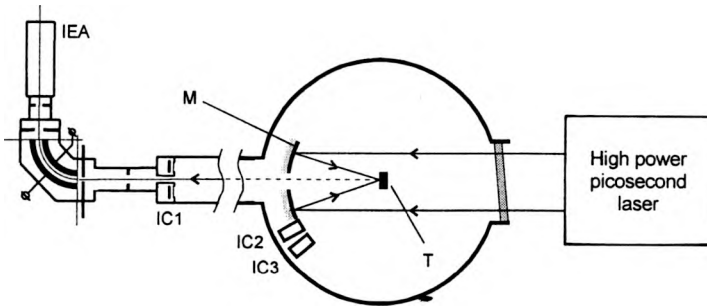

Fig. 1. Experimental arrangement. IEA – electrostatic ion-energy analyzer, IC1, IC2, IC3 – ion collectors, M – mirror, T – target.

By removing the grating compressor from the optical path of the CPA laser system and by keeping the geometry of the interaction unchanged, the laser system delivers 0.5 ns single pulses of high contrast ratio, with the wavelength, laser energy and divergence close to those of the ps pulses. The maximum intensity in this case was $2 \times 10^{14} \text{ W/cm}^2$.

The target holder mechanism makes it possible to move the target in the x and y directions (in the vertical plane perpendicular to the laser beam axis) to set fresh target surface on the laser beam axis and in the z direction (along the laser beam axis

perpendicular to the x - y plane) to change the focusing conditions. The focus position (FP) was changed within the range from -0.8 to 0.8 mm for ps pulses and from -1.4 to 0.8 mm for sub-ns pulses. $FP = 0$ means that the target surface is in the nominal in-focus position, the sign “+” is the laser beam focus spot is inside the target, and “-” is the laser beam focus spot is in front of the target surface. As it results from our X-ray measurements $FP = 0$ corresponds to the real in-focus position of the target surface for the case of ps pulses. However, for the case of sub-ns pulses the real in-focus position was shifted to $FP = -0.3$ mm (probably due to some differences in angular divergences of ps and sub-ns laser beams and possible self-focusing of the sub-ns beam in the plasma).

The plasma investigations were carried out by means of ion diagnostics employing the time-of-flight method [5]. An electrostatic ion-energy analyzer (IEA) as well as three ion collectors (IC1, IC2 and IC3) were placed at 0° , 26° and 34° angles with respect to the target normal at the distances of 110.3, 35.2 and 35.2 cm from the target, respectively. The IC1 collector is a ring-shape collector coaxial with the IEA. Therefore, it was possible to measure the charge distributions of the plasma by means of the IEA located behind the focusing mirror (at a distance of 189.6 cm from the target) simultaneously with the charge-integrated time resolved signals from the IC1 collector. The pressure inside the experimental chamber and the IEA was about 5×10^{-6} torr

3. Experimental results and observations

3.1. IEA and ion collector measurements

Charge integrated and time resolved ion current signals in both experiments have a multi-peak structure (Fig. 2) and show the existence of two or three ion groups: fast, thermal and a slow one. They deliver information on the charge carried by ions (or the number of ions), the velocity distribution and the angular expansion of the ion stream.

3.2. Maximum velocity of ions

The sub-ns laser pulse. The ion velocity reaches maximum value at $FP = -0.4$ mm, which amounts to about 3.2×10^8 cm/s (corresponding ion energy per nucleon $\varepsilon = E_{\max}/A \approx 53$ keV/a.m.u.). For $FP \neq -0.4$ mm the dependence smoothly decreases up to 10^8 cm/s at $FP = -1.4$ mm and $FP = 0.8$ mm, (Fig. 3, bottom).

The ps laser pulse. The maximum ion velocity occurs at FP close to -0.4 mm similarly to the sub-ns pulse and reaches the value of 5.2×10^8 cm/s (corresponding ion energy per nucleon $\varepsilon \approx 143$ keV/a.m.u.), (Fig. 3, top).

3.3. Peak velocity of fast, thermal and slow ion groups

Sub-ns laser pulse. For the fast and thermal ion groups clear maxima for the peak velocity exist at $FP = -0.4$ mm with peak velocities of about 1.7×10^8 cm/s for the

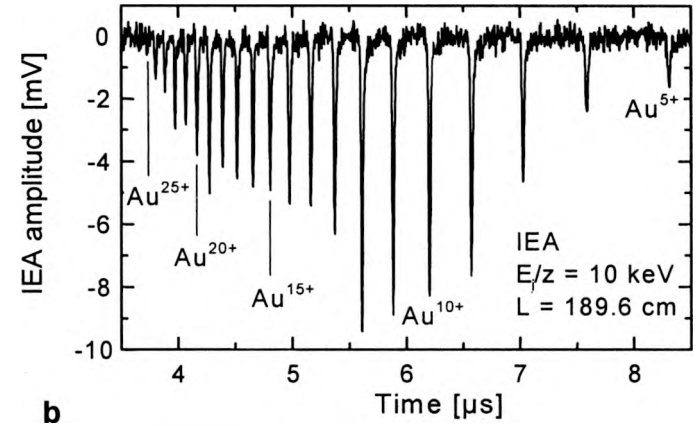
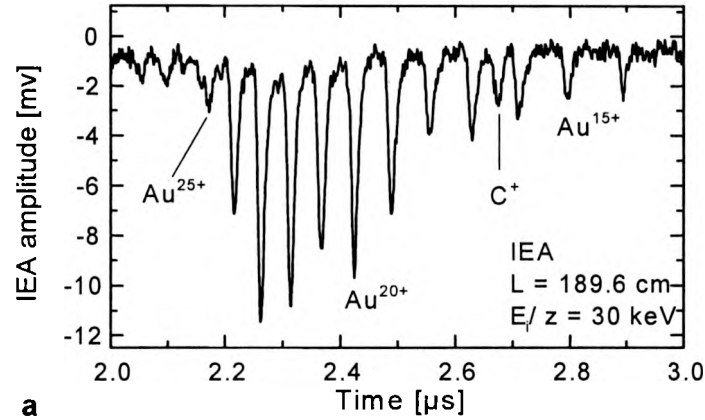
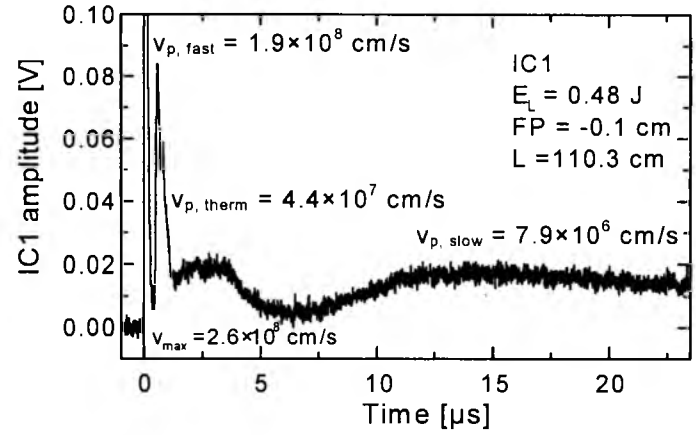
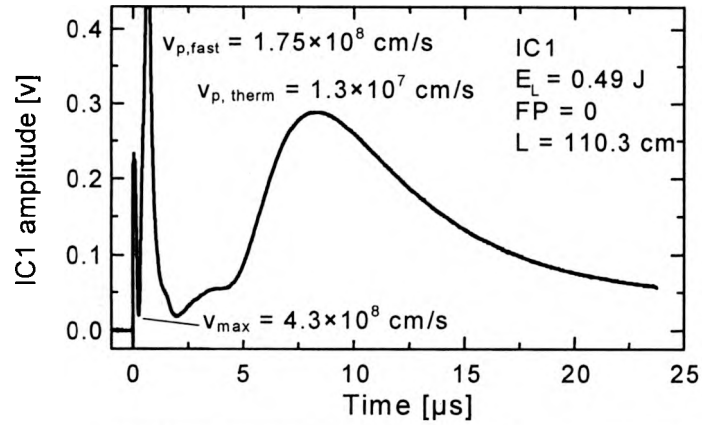

Fig. 2. IC1 collector signals (top) and IEA spectra (bottom) of Au ions for the ps (a) and the sub-ns (b) laser pulses.

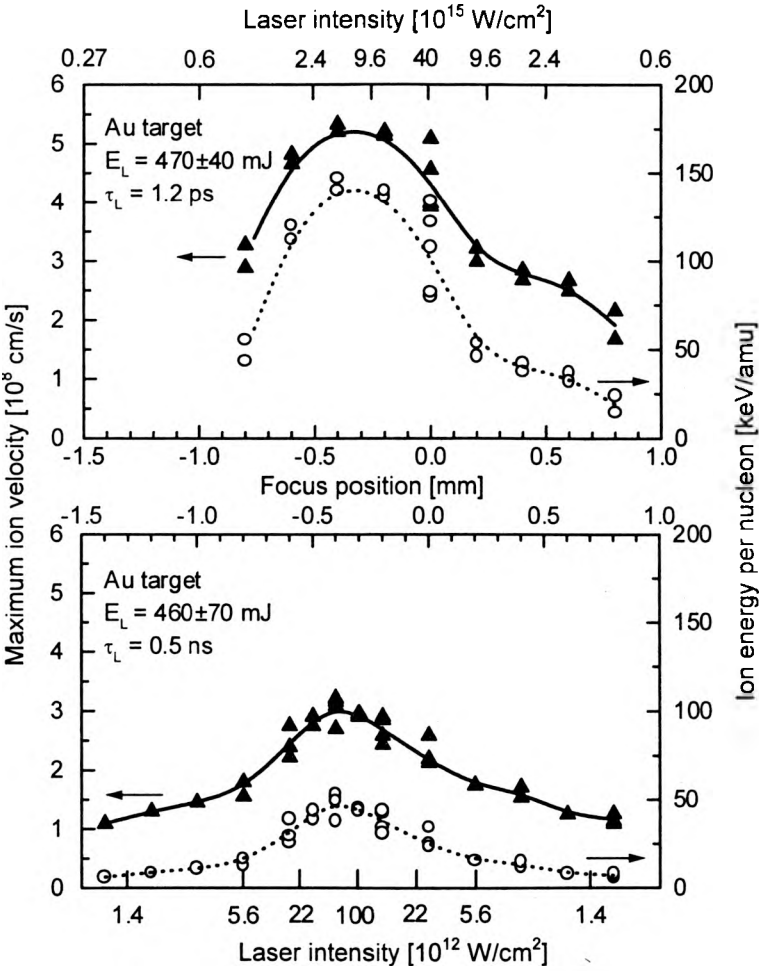

Fig. 3. Maximum ion velocity and ion energy per nucleon as a function of the focus position for the ps (top) and for the sub-ns (bottom) laser pulses. Estimated values of the laser intensity for a given FP are marked.

fast ion group and 0.8×10^8 cm/s for the thermal ion group. The peak velocity of the slow ion group is about one order of magnitude lower than that of the thermal ion group and takes values in the range of $(0.9 - 1) \times 10^7$ cm/s in the whole range of FP (Fig. 4).

The ps laser pulse. The maximum for the peak velocity of the fast group occurs near FP = 0 and takes a value of 2×10^8 cm/s while the peak velocity of the thermal group is nearly constant (about 2.5×10^7 cm/s) over the whole range of FP (Fig. 4). The slow ion group is not observed.

3.4. Maximum ion current density

The sub-ns laser pulse. Distinct minima of ion current density appear for the thermal and slow ion groups at FP = -0.4 mm and they have a value of about 0.1 mA/cm²

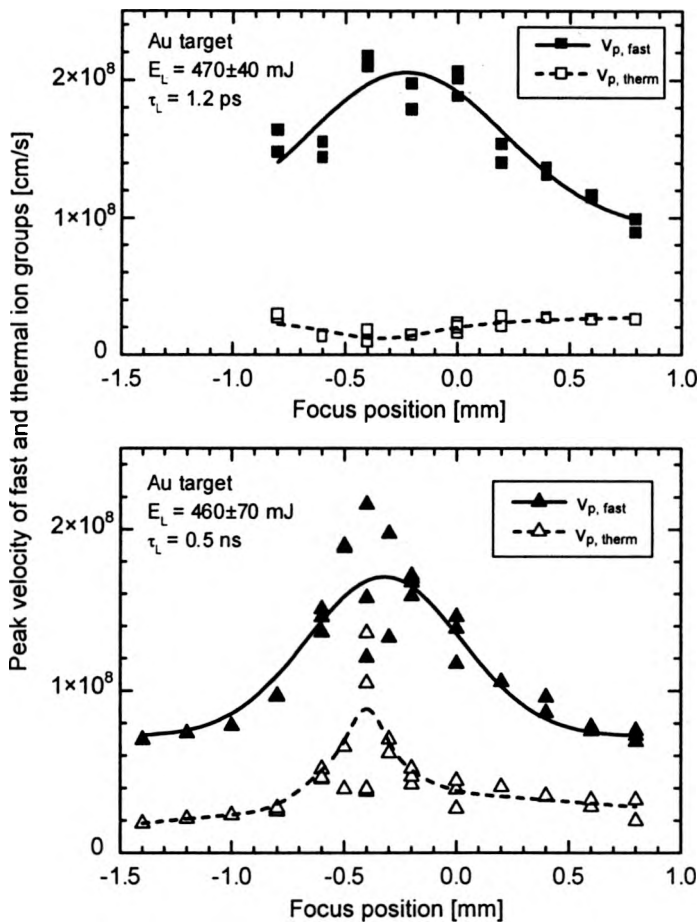

Fig. 4. Peak velocity of fast and thermal ion groups as a function of the focus position for the ps (top) and the sub-ps (bottom) laser pulses.

at a distance of 1 m from the target. For the fast ion group there is a maximum within the range of $-0.6 \text{ mm} < \text{FP} < -0.2 \text{ mm}$ where the current density is about 0.5 mA/cm^2 at 1 m, comparable to the current densities at $\text{FP} = -1.4 \text{ mm}$ and $\text{FP} = 0.8 \text{ mm}$. At $\text{FP} = -1.4 \text{ mm}$ and $\text{FP} = 0.8 \text{ mm}$ the ion current density of thermal ion group is about 3 times higher than that of the fast ion group (Fig. 5, bottom).

The ps laser pulse. The maximum of the ion current density for the fast ion group occurs at $\text{FP} = -0.2 \text{ mm}$ and takes values of about 2 mA/cm^2 at a distance of 1 m from the target. The ion current density for thermal ions has a minimum at $\text{FP} \approx 0$ and it attains the highest value (2 mA/cm^2 at 1 m) at $\text{FP} = 0.8 \text{ mm}$ (Fig. 5, top).

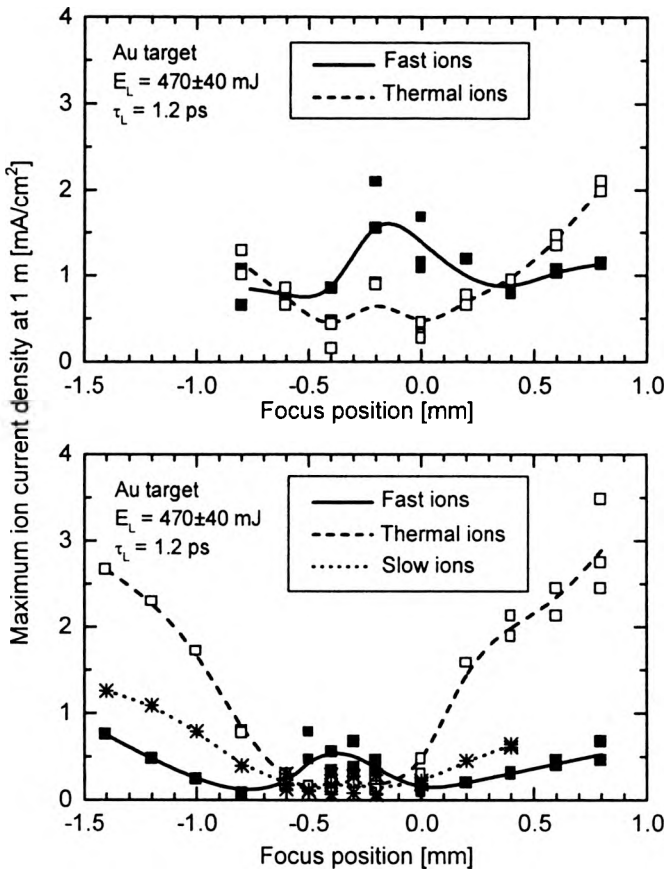

Fig. 5. Maximum ion current density as a function of the focus position for the ps (top) and the sub-ns (bottom) laser pulses.

3.5. Charge carried by fast and thermal ions in normal direction to the target

The sub-ns laser pulse. The dependences of the charge carried by the ions for thermal and fast ion groups are very similar to the ones for the maximum ion current densities. Over the range of $-0.6 \text{ mm} < \text{FP} < -0.2 \text{ mm}$ the value of the charge carried by fast ion group is nearly the same as for the strongly defocused laser beam, $\text{FP} = -1.4 \text{ mm}$ and $\text{FP} = 0.8 \text{ mm}$, and it is equal to about 2×10^{13} electrons/sr. For the defocused laser beam the charge carried by slow ion group is very large compared to that of the fast group and attains value of $(1.2-1.5) \times 10^{15}$ electrons/sr at $\text{FP} = -1.4 \text{ mm}$ and $\text{FP} = 0.8 \text{ mm}$, while for $-0.6 \text{ mm} < \text{FP} < -0.2 \text{ mm}$ the charge is comparable to that of the fast ion group.

The ps laser pulse. The charge carried by the fast group is about one order of magnitude lower than that of the thermal group and they both attain a maximum at $\text{FP} = -0.2 \text{ mm}$.

4. Conclusions

Both experiments show that the ion yield at a given laser energy depends essentially on the laser beam focusing condition. At the focus position near the real in-focus position the plasma parameters usually attain optimum values (maximum or minimum), independent of the laser pulse duration. Particularly, the maximum of fast ion current and the minimum of thermal ion current are observed near the real in-focus position both for the ps and the sub-ns laser pulses.

The ion current densities of fast ions for the ps pulses are higher (2–3 times) than the ones for the sub-ns pulses. The maximum-recorded values of the current densities of thermal ions are comparable for the ps and the sub-ns pulses.

The maximum ion energy per nucleon is nearly 3 times higher in the case of ps laser pulses.

Acknowledgments – The work was supported in part by the State Committee for Scientific Research (KBN), Poland, under the grant No. 2 P03B 082 19 and by the Grant Agency of the Academy of Sciences of the Czech Republic, under the grant No. A1010105.

References

- [1] HASEROTH H., HILL C.E., *Rev. Sci. Instrum.* **67** (1996), 1328.
- [2] GAMMINO S., CIAVOLA G., TORRISI L., *et al.*, *Rev. Sci. Instrum.* **71** (2000), 1119.
- [3] BOODY F.P., HÖPFL R., HORA H., *Laser Part. Beams* **14** (1996), 443.
- [4] WORYNA E., WOŁOWSKI J., KRÁLIKOVÁ B., *et al.*, *Rev. Sci. Instrum.* **71** (2000), 949.
- [5] WORYNA E., PARYS P., WOŁOWSKI J., MRÓZ W., *Laser Part. Beams* **14** (2000), 293.
- [6] BOIKO V.A., KROKHIN O.N., PIKUZ S.A., *et al.*, *Fiz. Plazmy* **1** (1975), 309, (in Russian).
- [7] GITOMER S.J., JONES R.D., BEGAY F., *et al.*, *Phys. Fluids* **29** (1986), 2679.
- [8] WORYNA E., PARYS P., WOŁOWSKI J., *et al.*, *Appl. Phys. Lett.* **69** (1996), 1547.
- [9] GUETHLEIN G., FORD M.E., PRICE D., *Phys. Rev. Lett.* **77** (1996), 1055.
- [10] CLARK E.L., KRUSHELNICK K., ZEPF M., *et al.*, *Phys. Rev. Lett.* **85** (2000), 1654.
- [11] BADZIAK J., PARYS P., VANKOV A.B., *et al.*, *Appl. Phys. Lett.* **78** (2001), 21.
- [12] BADZIAK J., WORYNA E., PARYS P., *et al.*, *Phys. Rev. Lett.* **87** (2001), 215001.
- [13] BADZIAK J., CHIZHOV S.A., KOZLOV A.A., *et al.*, *Optics Commun.* **134** (1997), 495.

Received October 19, 2001